



OSRAM Opto Semiconductors, Inc.

SFH 7710

Part Number: SFH 7710
 Manufacturer/Brand: OSRAM Opto Semiconductors, Inc.
 Product description: SENSOR TILT DIGITAL 10MA SMD
 Datasheets: [SFH 7710.pdf](#)
 RoHS Status:  Lead free / RoHS Compliant
 Ship From: Hong Kong
 Shipment Way: DHL/Fedex/TNT/UPS/EMS

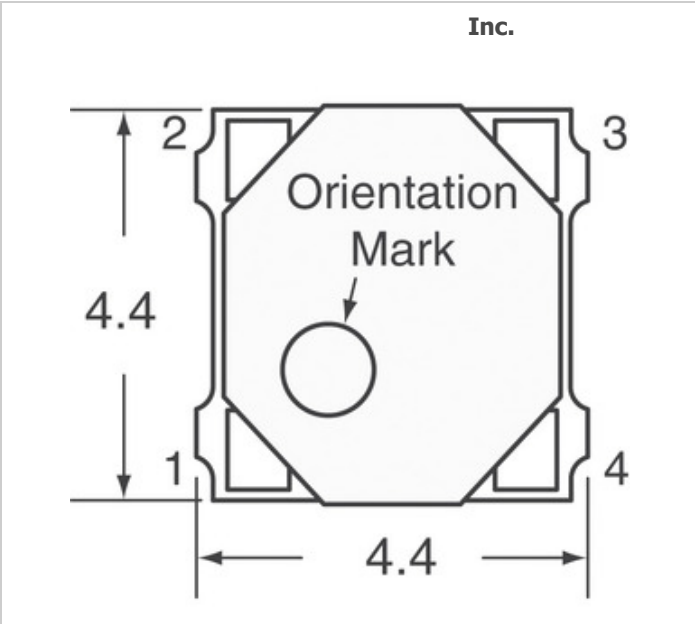

Image may be representation. See specifications for product details.

[REQUEST FOR QUOTATION](#)











Specifications of SFH 7710

PART NUMBER	SFH 7710
MANUFACTURER	OSRAM Opto Semiconductors, Inc.
DESCRIPTION	SENSOR TILT DIGITAL 10MA SMD
LEAD FREE STATUS / ROHS STATUS	Lead free / RoHS Compliant
DATA SHEET	SFH 7710.pdf
VOLTAGE - SUPPLY	2.3 V ~ 3.6 V
SERIES	-
PACKAGING	Tape & Reel (TR)
PACKAGE / CASE	4-SMD
OUTPUT TYPE	Digital, Open Drain
OTHER NAMES	475-1269-2 Q3437777 Q65110A4407 SFH 7710-Z
OPERATING TEMPERATURE	-20°C ~ 65°C
OPERATING ANGLE	-
MOUNTING TYPE	Surface Mount
MOISTURE SENSITIVITY LEVEL (MSL)	4 (72 Hours)
LEAD FREE STATUS / ROHS STATUS	Lead free / RoHS Compliant
CURRENT - OUTPUT	10mA

Related Tags

OSRAM Opto Semiconductors, Inc. SFH 7710	SFH 7710 Distributor	SFH 7710 Supplier
SFH 7710 Price	SFH 7710 Pictures	SFH 7710 Image
SFH 7710 PDF Datasheet	SFH 7710 Download Datasheet	SFH 7710 Datasheet
SFH 7710 Stock	Buy SFH 7710	Buy OSRAM Opto Semiconductors, Inc. SFH 7710
OSRAM Opto Semiconductors, Inc. SFH 7710	OSRAM Opto Semiconductors, Inc. Supplier	OSRAM Opto Semiconductors, Inc. Distributor
OSRAM Opto Semiconductors, Inc. SFH 7710	OSRAM Opto Semiconductors Inc. SFH 7710	

Related Products

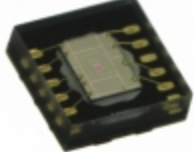
 <p>SFH 7225-Z Manufacturers: OSRAM Opto Semiconductors, Inc. Description: LED YELLOW CLEAR SMD In stock: Out stock RFQ</p>	 <p>SFH 7251 Manufacturers: OSRAM Opto Semiconductors, Inc. Description: EMITTER IR MULTI TOPLED In stock: Out stock RFQ</p>
 <p>SFH 757 Manufacturers: International Rectifier (Infineon Technologies) Description: TRANSMITTER DIODE FIBER OPTIC In stock: Out stock RFQ</p>	 <p>SFH 7250 Manufacturers: OSRAM Opto Semiconductors, Inc. Description: EMITTER IR 850NM In stock: Out stock RFQ</p>
 <p>SFH 7771 Manufacturers: OSRAM Opto Semiconductors, Inc. Description: CHIP ON BOARD In stock: Out stock RFQ</p>	 <p>SFH 7770 E6 Manufacturers: OSRAM Opto Semiconductors, Inc. Description: ALS, PROXIMITY SENSOR (2-IN-1) In stock: Out stock RFQ</p>
 <p>SFH 7252 Manufacturers: OSRAM Opto Semiconductors, Inc. Description: MULTI TOPLED In stock: Out stock RFQ</p>	 <p>SFH 7741-Z Manufacturers: OSRAM Opto Semiconductors, Inc. Description: PROXIMITY SENSOR 30MM In stock: Out stock RFQ</p>
 <p>SFH 7740-Z Manufacturers: OSRAM Opto Semiconductors, Inc. Description: SENSOR OPTO REFLECTIVE 6SMD In stock: Out stock RFQ</p>	 <p>SFH 757V Manufacturers: International Rectifier (Infineon Technologies) Description: TRANSMITTER DIODE FIBER OPTIC In stock: Out stock RFQ</p>
 <p>SFH 7743-Z Manufacturers: OSRAM Opto Semiconductors, Inc. Description: PHOTODETECTOR SCHMITT SMD In stock: Out stock RFQ</p>	 <p>SFH 7770 Manufacturers: OSRAM Opto Semiconductors, Inc. Description: LIGHT SENSOR AMBIENT SMD In stock: Out stock RFQ</p>

