

Honeywell

Honeywell Sensing and Productivity Solutions

1NT887-7

Part Number: 1NT887-7
 Manufacturer/Brand: Honeywell Sensing and Productivity Solutions
 Product description: SWITCH TOGGLE SPDT 10A 125V
 Datasheets: [1.1NT887-7.pdf](#)
[2.1NT887-7.pdf](#)
[3.1NT887-7.pdf](#)
 RoHS Status:  Lead free / RoHS Compliant
 Ship From: Hong Kong
 Shipment Way: DHL/Fedex/TNT/UPS/EMS

Productivity Solutions

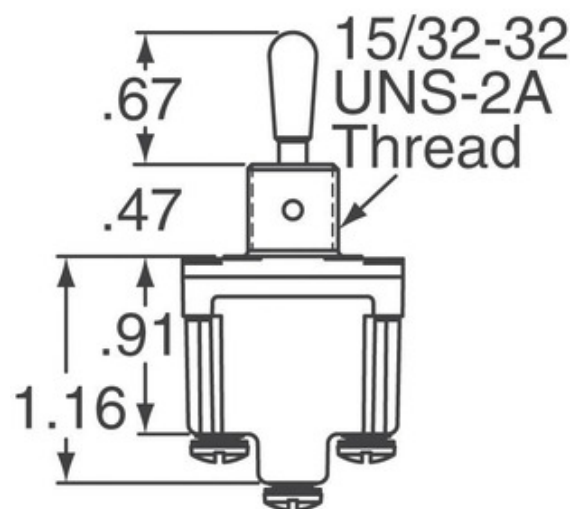

REQUEST FOR QUOTATION

Image may be representation. See specifications for product details.







Specifications of 1NT887-7

PART NUMBER	1NT887-7
MANUFACTURER	Honeywell Sensing and Productivity Solutions
DESCRIPTION	SWITCH TOGGLE SPDT 10A 125V
LEAD FREE STATUS / ROHS STATUS	Lead free / RoHS Compliant
DATA SHEET	1.1NT887-7.pdf 2.1NT887-7.pdf 3.1NT887-7.pdf
VOLTAGE RATING - AC	125V
TERMINATION STYLE	Screw Terminal
SWITCH FUNCTION	Mom-Off-Mom
SERIES	NT
PANEL CUTOUT DIMENSIONS	Circular - 12.40mm Dia
PACKAGING	Bulk
OPERATING TEMPERATURE	-40°C ~ 71°C
MOUNTING TYPE	Panel Mount
MOISTURE SENSITIVITY LEVEL (MSL)	1 (Unlimited)
LEAD FREE STATUS / ROHS STATUS	Lead free / RoHS Compliant
INGRESS PROTECTION	Environment Proof
ILLUMINATION VOLTAGE (NOMINAL)	-
ILLUMINATION TYPE, COLOR	-
ILLUMINATION	Non-Illuminated
FEATURES	-
ELECTRICAL LIFE	-
DETAILED DESCRIPTION	Toggle Switch SPDT Panel Mount
CURRENT RATING	10A (AC)
CIRCUIT	SPDT
BUSHING THREAD	15/32-32
ACTUATOR TYPE	Standard Round
ACTUATOR MATERIAL	-
ACTUATOR LENGTH	17.02mm

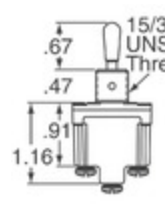
Related Tags

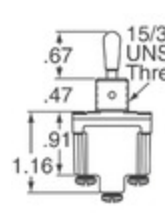
Honeywell Sensing and Productivity Solutions 1NT887-7	1NT887-7 Distributor	1NT887-7 Supplier
1NT887-7 Price	1NT887-7 Pictures	1NT887-7 Image
1NT887-7 PDF Datasheet	1NT887-7 Download Datasheet	1NT887-7 Datasheet
1NT887-7 Stock	Buy 1NT887-7	Buy Honeywell Sensing and Productivity Solutions 1NT887-7
Honeywell Sensing and Productivity Solutions 1NT887-7	Honeywell Sensing and Productivity Solutions Supplier	Honeywell Sensing and Productivity Solutions Distributor
Honeywell Sensing and Productivity Solutions 1NT887-7	HONEYWELL 1NT887-7	Honeywell Sensing and Control EMEA 1NT887-7
Honeywell Sensing and Productivity Solutions T&M 1NT887-7		

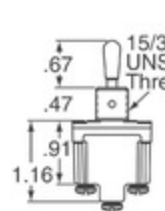
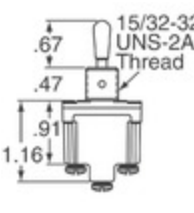
Related Products

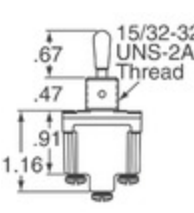
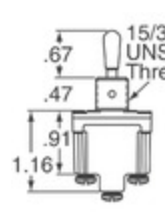
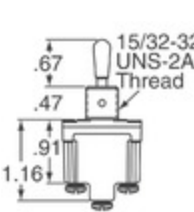
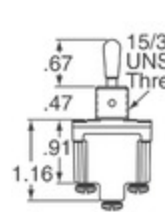
 <p>1NT91-3 Manufacturers: Honeywell Sensing and Productivity Solutions Description: SWITCH TOGGLE SPDT 15A 125V In stock: Out stock RFQ</p>	 <p>1NT887-21K Manufacturers: Honeywell Sensing and Productivity Solutions Description: SWITCH TOGGLE SPST 15A 125V In stock: Out stock RFQ</p>
 <p>1NT887-2 Manufacturers: Honeywell Sensing and Productivity Solutions Description: SWITCH TOGGLE SPST 15A 125V In stock: 3 pcs RFQ</p>	 <p>1NT20-7N Manufacturers: Honeywell Sensing and Productivity Solutions Description: SWITCH TOGGLE SPDT 10A 125V In stock: Out stock RFQ</p>
 <p>1NT91-2 Manufacturers: Honeywell Sensing and Productivity Solutions Description: SWITCH TOGGLE SPST 15A 125V In stock: Out stock RFQ</p>	 <p>1NT91-3D Manufacturers: Honeywell Sensing and Productivity Solutions Description: SWITCH TOGGLE SPDT 15A 125V In stock: Out stock RFQ</p>
 <p>1NT887-3 Manufacturers: Honeywell Sensing and Productivity Solutions Description: SWITCH TOGGLE SPDT 15A 125V In stock: Out stock RFQ</p>	 <p>1NT91-1 Manufacturers: Honeywell Sensing and Productivity Solutions Description: SWITCH TOGGLE SPDT 15A 125V In stock: Out stock RFQ</p>
 <p>1NT887-7E Manufacturers: Honeywell Sensing and Productivity Solutions Description: SWITCH TOGGLE SPDT 10A 125V In stock: Out stock RFQ</p>	 <p>1NT231-7 Manufacturers: Honeywell Sensing and Productivity Solutions Description: SWITCH TOGGLE SPDT 10A 125V In stock: Out stock RFQ</p>
 <p>1NT887-6 Manufacturers: Honeywell Sensing and Productivity Solutions Description: SWITCH TOGGLE SPST-NO 10A 125V In stock: Out stock RFQ</p>	 <p>1NT91-1E Manufacturers: Honeywell Sensing and Productivity Solutions Description: SWITCH TOGGLE SPDT 15A 125V In stock: Out stock RFQ</p>