

Honeywell

Honeywell Sensing and

MLH016BSM05G

Part Number:	MLH016BSM05G
Manufacturer/Brand:	Honeywell Sensing and Productivity Solutions
Product description:	MLH ALL METAL PRESS SENSE -ATF
Datasheets:	1.MLH016BSM05G.pdf 2.MLH016BSM05G.pdf
RoHS Status:	 Lead free / RoHS Compliant
Ship From:	Hong Kong
Shipment Way:	DHL/Fedex/TNT/UPS/EMS

Productivity Solutions

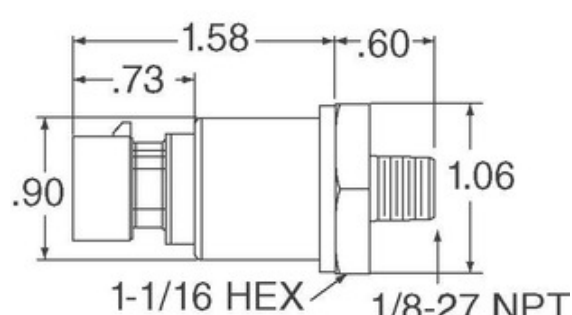

Image may be representation. See specifications for product details.

[REQUEST FOR QUOTATION](#)









Specifications of MLH016BSM05G

PART NUMBER	MLH016BSM05G
MANUFACTURER	Honeywell Sensing and Productivity Solutions
DESCRIPTION	MLH ALL METAL PRESS SENSE -ATF
LEAD FREE STATUS / ROHS STATUS	Lead free / RoHS Compliant
DATA SHEET	1.MLH016BSM05G.pdf 2.MLH016BSM05G.pdf
VOLTAGE - SUPPLY	8 V ~ 30 V
SUPPLIER DEVICE PACKAGE	-
SERIES	MLH
PRESSURE TYPE	Sealed Gauge
PORT STYLE	Threaded
PORT SIZE	Male - M18 x 1.5
PACKAGE / CASE	Cylinder, Metal
OUTPUT TYPE	Analog Voltage
OUTPUT	1 V ~ 5 V
OPERATING TEMPERATURE	-40°C ~ 125°C
OPERATING PRESSURE	232.06 PSI (1600 kPa)
MOISTURE SENSITIVITY LEVEL (MSL)	1 (Unlimited)
MAXIMUM PRESSURE	696.18 PSI (4800 kPa)
LEAD FREE STATUS / ROHS STATUS	Lead free / RoHS Compliant
FEATURES	Amplified Output, Temperature Compensated
DETAILED DESCRIPTION	Pressure Sensor 232.06 PSI (1600 kPa) Sealed Gauge Male - M18 x 1.5 1 V ~ 5 V Cylinder, Metal
ACCURACY	±0.25%

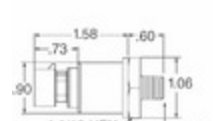
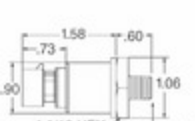
Related Tags

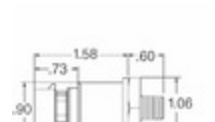
Honeywell Sensing and Productivity Solutions MLH016BSM05G	MLH016BSM05G Distributor	MLH016BSM05G Supplier
MLH016BSM05G Price	MLH016BSM05G Pictures	MLH016BSM05G Image
MLH016BSM05G PDF Datasheet	MLH016BSM05G Download Datasheet	MLH016BSM05G Datasheet
MLH016BSM05G Stock	Buy MLH016BSM05G	Buy Honeywell Sensing and Productivity Solutions MLH016BSM05G
Honeywell Sensing and Productivity Solutions MLH016BSM05G	Honeywell Sensing and Productivity Solutions Supplier	Honeywell Sensing and Productivity Solutions Distributor
Honeywell Sensing and Productivity Solutions MLH016BSM05G	HONEYWELL MLH016BSM05G	Honeywell Sensing and Control EMEA MLH016BSM05G
Honeywell Sensing and Productivity Solutions T&M MLH016BSM05G		

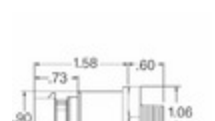
Related Products

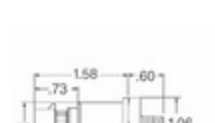
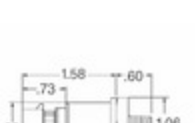
 <p>MLH016BSM01B Manufacturers: Honeywell Sensing and Productivity Solutions Description: SENSOR SEALED GAUGE 0-16 BAR In stock: Out stock</p> <p>RFQ</p>	 <p>MLH01KPSB01B Manufacturers: Honeywell Sensing and Productivity Solutions Description: SENSOR AMP 1000PSI 4-20MA OUT In stock: 40 pcs</p> <p>RFQ</p>
 <p>MLH017BSB01A Manufacturers: Honeywell Sensing and Productivity Solutions Description: SENSOR SEALED GAUGE 0-17 BAR In stock: Out stock</p> <p>RFQ</p>	 <p>MLH016BSB01E Manufacturers: Honeywell Sensing and Productivity Solutions Description: MLH ALL METAL PRESS SENSE -ATF In stock: Out stock</p> <p>RFQ</p>
 <p>MLH016BSM14B Manufacturers: Honeywell Sensing and Productivity Solutions Description: MLH ALL METAL PRESS SENSE -ATF In stock: Out stock</p> <p>RFQ</p>	 <p>MLH016BSB14B Manufacturers: Honeywell Sensing and Productivity Solutions Description: SENSOR SEALED GAUGE 0-16 BAR In stock: Out stock</p> <p>RFQ</p>
 <p>MLH01KPGB06C Manufacturers: Honeywell Sensing and Productivity Solutions Description: MLH ALL METAL PRESS SENSE -ATF In stock: Out stock</p> <p>RFQ</p>	 <p>MLH01KPSB01A Manufacturers: Honeywell Sensing and Productivity Solutions Description: SENSOR AMP 1000PSI .5-4.5VDC In stock: 78 pcs</p> <p>RFQ</p>
 <p>MLH016BSG17B Manufacturers: Honeywell Sensing and Productivity Solutions Description: MLH ALL METAL PRESS SENSE -ATF In stock: Out stock</p> <p>RFQ</p>	 <p>MLH016BSG01B Manufacturers: Honeywell Sensing and Productivity Solutions Description: SENSOR SEALED GAUGE 0-16 BAR In stock: Out stock</p> <p>RFQ</p>
 <p>MLH016BSH14A Manufacturers: Honeywell Sensing and Productivity Solutions Description: MLH ALL METAL PRESS SENSE -ATF In stock: Out stock</p> <p>RFQ</p>	 <p>MLH01KPGB01B Manufacturers: Honeywell Sensing and Productivity Solutions Description: MLH ALL METAL PRESS SENSE -ATF In stock: Out stock</p> <p>RFQ</p>