

Panasonic

Panasonic

HC2E-H-AC48V-F

Part Number: HC2E-H-AC48V-F

Manufacturer/Brand: Panasonic

Product description: HC RELAY 2 FORM C 48VAC

Datasheets: [HC2E-H-AC48V-F.pdf](#)

RoHS Status:  Lead free / RoHS Compliant

Ship From: Hong Kong

Shipment Way: DHL/Fedex/TNT/UPS/EMS

HC2E-H-AC48V-F

Panasonic

HC RELAY 2 FORM C 48VAC

[HC2E-H-AC48V-F.pdf](#)

 Lead free / RoHS Compliant

Hong Kong

DHL/Fedex/TNT/UPS/EMS

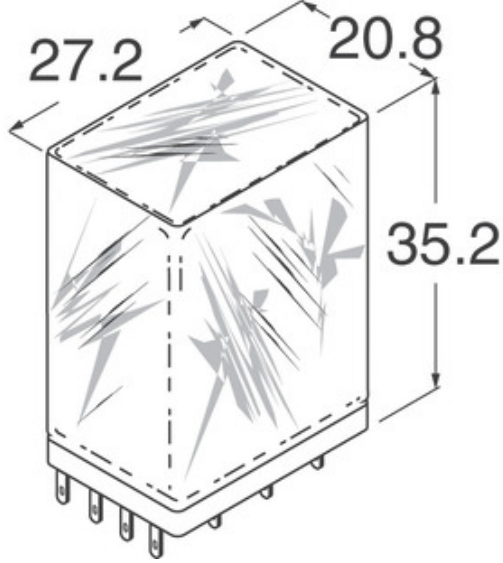

Image may be representation. See specifications for product details.

[REQUEST FOR QUOTATION](#)











Specifications of HC2E-H-AC48V-F

PART NUMBER	HC2E-H-AC48V-F
MANUFACTURER	Panasonic
DESCRIPTION	HC RELAY 2 FORM C 48VAC
LEAD FREE STATUS / ROHS STATUS	Lead free / RoHS Compliant
DATA SHEET	HC2E-H-AC48V-F.pdf
SERIES	*
MOISTURE SENSITIVITY LEVEL (MSL)	1 (Unlimited)
LEAD FREE STATUS / ROHS STATUS	Lead free / RoHS Compliant
DETAILED DESCRIPTION	Relay Coil

Related Tags

Panasonic HC2E-H-AC48V-F	HC2E-H-AC48V-F Distributor	HC2E-H-AC48V-F Supplier
HC2E-H-AC48V-F Price	HC2E-H-AC48V-F Pictures	HC2E-H-AC48V-F Image
HC2E-H-AC48V-F PDF Datasheet	HC2E-H-AC48V-F Download Datasheet	HC2E-H-AC48V-F Datasheet
HC2E-H-AC48V-F Stock	Buy HC2E-H-AC48V-F	Buy Panasonic HC2E-H-AC48V-F
Panasonic HC2E-H-AC48V-F	Panasonic Supplier	Panasonic Distributor
Panasonic HC2E-H-AC48V-F	Panasonic - Consumer Division HC2E-H-AC48V-F	Panasonic - Consumer Electronics Corp. HC2E-H-AC48V-F
Panasonic Battery Group HC2E-H-AC48V-F	Panasonic Electric Works - ACSD HC2E-H-AC48V-F	Panasonic Electronic Components - Semiconductor Pr HC2E-H-AC48V-F
Panasonic - ATG HC2E-H-AC48V-F	Panasonic - BSG HC2E-H-AC48V-F	Panasonic - DTG HC2E-H-AC48V-F
Panasonic Electric Works HC2E-H-AC48V-F	Panasonic Electronic Components HC2E-H-AC48V-F	Panasonic Industrial Automation Sales HC2E-H-AC48V-F
Panasonic Semiconductor HC2E-H-AC48V-F		

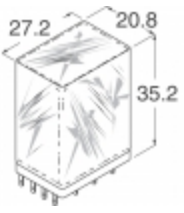
Related Products

 <p>HC2E-H-AC6V-F Manufacturers: Panasonic Description: HC RELAY 2 FORM C 6VAC In stock: Out stock RFQ</p>	 <p>HC2E-H-DC110V-F Manufacturers: Panasonic Description: HC RELAY In stock: Out stock RFQ</p>
 <p>HC2E-H-AC6V Manufacturers: Panasonic Description: RELAY GENERAL PURPOSE DPDT 3A 6V In stock: Out stock RFQ</p>	 <p>HC2E-H-AC24V Manufacturers: Panasonic Description: RELAY GEN PURPOSE DPDT 3A 24V In stock: Out stock RFQ</p>
 <p>HC2E-H-AC200V-F Manufacturers: Panasonic Description: RELAY GEN PURP DPDT 200VAC In stock: Out stock RFQ</p>	 <p>HC2E-H-AC24V-F Manufacturers: Panasonic Description: HC RELAY 2 FORM C 24VAC In stock: Out stock RFQ</p>
 <p>HC2E-H-DC100V-F Manufacturers: Panasonic Description: RELAY GEN PURP DPDT 100VDC In stock: Out stock RFQ</p>	 <p>HC2E-H-DC12V Manufacturers: Panasonic Description: RELAY GEN PURPOSE DPDT 3A 12V In stock: Out stock RFQ</p>
 <p>HC2E-H-DC110V Manufacturers: Panasonic Description: RELAY GEN PURPOSE DPDT 3A 110V In stock: Out stock RFQ</p>	 <p>HC2E-H-AC240V-F Manufacturers: Panasonic Description: HC RELAY 2 FORM C 240VAC In stock: Out stock RFQ</p>
 <p>HC2E-H-AC240V Manufacturers: Panasonic Description: RELAY GEN PURPOSE DPDT 3A 240V In stock: Out stock RFQ</p>	 <p>HC2E-H-AC48V Manufacturers: Panasonic Description: RELAY GEN PURPOSE DPDT 3A 48V In stock: Out stock RFQ</p>