

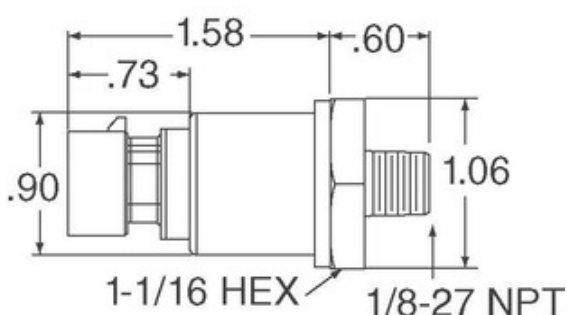



Honeywell Sensing and

Productivity Solutions



MLH150BSH08A

Part Number:	MLH150BSH08A
Manufacturer/Brand:	Honeywell Sensing and Productivity Solutions
Product description:	MLH ALL METAL PRESS SENSE -ATF
Datasheets:	1.MLH150BSH08A.pdf 2.MLH150BSH08A.pdf
RoHS Status:	 Lead free / RoHS Compliant
Ship From:	Hong Kong
Shipment Way:	DHL/Fedex/TNT/UPS/EMS

[REQUEST FOR QUOTATION](#)

Image may be representation. See specifications for product details.







Specifications of MLH150BSH08A

PART NUMBER	MLH150BSH08A
MANUFACTURER	Honeywell Sensing and Productivity Solutions
DESCRIPTION	MLH ALL METAL PRESS SENSE -ATF
LEAD FREE STATUS / ROHS STATUS	Lead free / RoHS Compliant
DATA SHEET	1.MLH150BSH08A.pdf 2.MLH150BSH08A.pdf
VOLTAGE - SUPPLY	5 V ~ 6 V
SUPPLIER DEVICE PACKAGE	-
SERIES	MLH
PRESSURE TYPE	Sealed Gauge
PORT STYLE	Threaded
PORT SIZE	Male - M10 x 1
PACKAGE / CASE	Cylinder, Metal
OUTPUT TYPE	Analog Voltage
OUTPUT	0.5 V ~ 4.5 V
OPERATING TEMPERATURE	-40°C ~ 125°C
OPERATING PRESSURE	2175.57 PSI (15000 kPa)
MOISTURE SENSITIVITY LEVEL (MSL)	1 (Unlimited)
MAXIMUM PRESSURE	-
LEAD FREE STATUS / ROHS STATUS	Lead free / RoHS Compliant
FEATURES	Amplified Output, Temperature Compensated
DETAILED DESCRIPTION	Pressure Sensor 2175.57 PSI (15000 kPa) Sealed Gauge Male - M10 x 1 0.5 V ~ 4.5 V Cylinder, Metal
ACCURACY	±0.25%

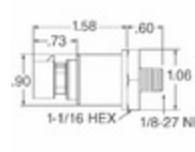
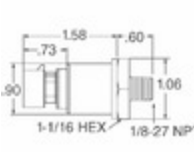
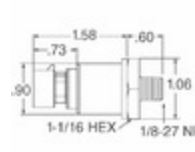
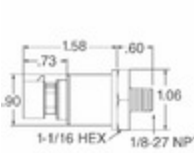
Related Tags

Honeywell Sensing and Productivity Solutions MLH150BSH08A	MLH150BSH08A Distributor	MLH150BSH08A Supplier
MLH150BSH08A Price	MLH150BSH08A Pictures	MLH150BSH08A Image
MLH150BSH08A PDF Datasheet	MLH150BSH08A Download Datasheet	MLH150BSH08A Datasheet
MLH150BSH08A Stock	Buy MLH150BSH08A	Buy Honeywell Sensing and Productivity Solutions MLH150BSH08A
Honeywell Sensing and Productivity Solutions MLH150BSH08A	Honeywell Sensing and Productivity Solutions Supplier	Honeywell Sensing and Productivity Solutions Distributor
Honeywell Sensing and Productivity Solutions MLH150BSH08A	HONEYWELL MLH150BSH08A	Honeywell Sensing and Control EMEA MLH150BSH08A
Honeywell Sensing and Productivity Solutions T&M MLH150BSH08A		

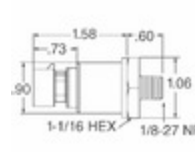
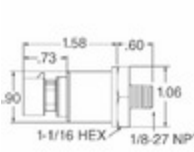
Related Products

 <p>MLH150PGB06A Manufacturers: Honeywell Sensing and Productivity Solutions Description: SENSOR AMP 150PSI .5-4.5VDC OUT In stock: 36 pcs</p> <p>RFQ</p>	 <p>MLH125PGB01C Manufacturers: Honeywell Sensing and Productivity Solutions Description: MLH ALL METAL PRESS SENSE GAUGE In stock: Out stock</p> <p>RFQ</p>
 <p>MLH110BST10A Manufacturers: Honeywell Sensing and Productivity Solutions Description: SENSOR SEALED GAUGE 0-110 BAR In stock: Out stock</p> <p>RFQ</p>	 <p>MLH150BSL03B Manufacturers: Honeywell Sensing and Productivity Solutions Description: SENSOR SEALED GAUGE 0-150 PSI In stock: Out stock</p> <p>RFQ</p>
 <p>MLH125PGB06A Manufacturers: Honeywell Sensing and Productivity Solutions Description: MLH ALL METAL PRESS SENSE -ATF In stock: Out stock</p> <p>RFQ</p>	 <p>MLH150PAB01A Manufacturers: Honeywell Sensing and Productivity Solutions Description: SENSOR AMP 150PSI .5-4.5VDC OUT In stock: Out stock</p> <p>RFQ</p>
 <p>MLH125PGL01C Manufacturers: Honeywell Sensing and Productivity Solutions Description: MLH ALL METAL PRESS SENSE GAUGE In stock: 6 pcs</p> <p>RFQ</p>	 <p>MLH150PGB01A Manufacturers: Honeywell Sensing and Productivity Solutions Description: SENSOR AMP 150PSI .5-4.5VDC OUT In stock: 49 pcs</p> <p>RFQ</p>
 <p>MLH150PGB01B Manufacturers: Honeywell Sensing and Productivity Solutions Description: SENSOR AMP 150PSI 4-20MA OUT In stock: 2 pcs</p> <p>RFQ</p>	 <p>MLH125PGB06C Manufacturers: Honeywell Sensing and Productivity Solutions Description: MLH ALL METAL PRESS SENSE GAUGE In stock: Out stock</p> <p>RFQ</p>
 <p>MLH125PGB06B Manufacturers: Honeywell Sensing and Productivity Solutions Description: MLH ALL METAL PRESS SENSE -ATF In stock: Out stock</p> <p>RFQ</p>	 <p>MLH150PGB06B Manufacturers: Honeywell Sensing and Productivity Solutions Description: SENSOR AMP 150PSI 4-20MA OUT In stock: Out stock</p> <p>RFQ</p>