



Honeywell Sensing and

MLH250BSD13D

Part Number:	MLH250BSD13D
Manufacturer/Brand:	Honeywell Sensing and Productivity Solutions
Product description:	MLH ALL METAL PRESS SENSE -ATF
Datasheets:	PDF 1.MLH250BSD13D.pdf PDF 2.MLH250BSD13D.pdf
RoHS Status:	 Lead free / RoHS Compliant
Ship From:	Hong Kong
Shipment Way:	DHL/Fedex/TNT/UPS/EMS

[REQUEST FOR QUOTATION](#)

Productivity Solutions

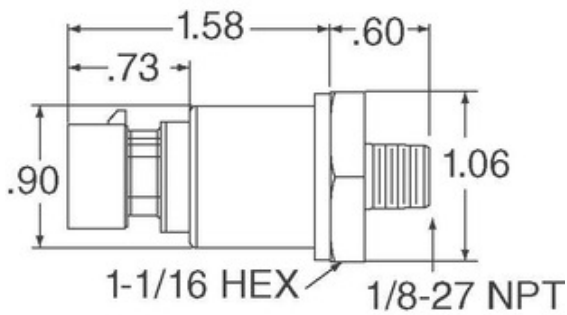

Image may be representation. See specifications for product details.







Specifications of MLH250BSD13D

PART NUMBER	MLH250BSD13D
MANUFACTURER	Honeywell Sensing and Productivity Solutions
DESCRIPTION	MLH ALL METAL PRESS SENSE -ATF
LEAD FREE STATUS / ROHS STATUS	Lead free / RoHS Compliant
DATA SHEET	PDF 1.MLH250BSD13D.pdf PDF 2.MLH250BSD13D.pdf
VOLTAGE - SUPPLY	14 V ~ 30 V
SUPPLIER DEVICE PACKAGE	-
SERIES	MLH
PRESSURE TYPE	Sealed Gauge
PORT STYLE	Threaded
PORT SIZE	Male - 1/4" (6.35mm) BSPT
PACKAGE / CASE	Cylinder, Metal
OUTPUT TYPE	Analog Voltage
OUTPUT	0.25 V ~ 10.25 V
OPERATING TEMPERATURE	-40°C ~ 125°C
OPERATING PRESSURE	3625.94 PSI (25000 kPa)
MOISTURE SENSITIVITY LEVEL (MSL)	1 (Unlimited)
MAXIMUM PRESSURE	7251.89 PSI (50000 kPa)
LEAD FREE STATUS / ROHS STATUS	Lead free / RoHS Compliant
FEATURES	Amplified Output, Temperature Compensated
DETAILED DESCRIPTION	Pressure Sensor 3625.94 PSI (25000 kPa) Sealed Gauge Male - 1/4" (6.35mm) BSPT 0.25 V ~ 10.25 V Cylinder, Metal
ACCURACY	±0.25%

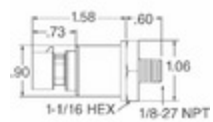
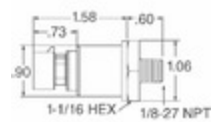
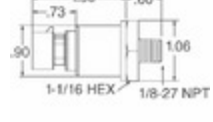
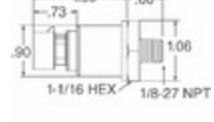
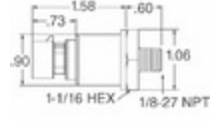
Related Tags

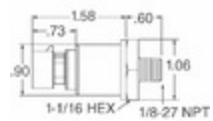
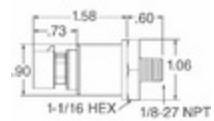
Honeywell Sensing and Productivity Solutions MLH250BSD13D	MLH250BSD13D Distributor	MLH250BSD13D Supplier
MLH250BSD13D Price	MLH250BSD13D Pictures	MLH250BSD13D Image
MLH250BSD13D PDF Datasheet	MLH250BSD13D Download Datasheet	MLH250BSD13D Datasheet
MLH250BSD13D Stock	Buy MLH250BSD13D	Buy Honeywell Sensing and Productivity Solutions MLH250BSD13D
Honeywell Sensing and Productivity Solutions MLH250BSD13D	Honeywell Sensing and Productivity Solutions Supplier	Honeywell Sensing and Productivity Solutions Distributor
Honeywell Sensing and Productivity Solutions MLH250BSD13D	HONEYWELL MLH250BSD13D	Honeywell Sensing and Control EMEA MLH250BSD13D
Honeywell Sensing and Productivity Solutions T&M MLH250BSD13D		

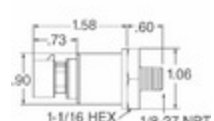
Related Products

 <p>MLH250BSB11D Manufacturers: Honeywell Sensing and Productivity Solutions Description: MLH ALL METAL PRESS SENSE -ATF In stock: Out stock</p> <p>RFQ</p>	 <p>MLH250BSD17D Manufacturers: Honeywell Sensing and Productivity Solutions Description: MLH ALL METAL PRESS SENSE -ATF In stock: Out stock</p> <p>RFQ</p>
 <p>MLH250BSG13B Manufacturers: Honeywell Sensing and Productivity Solutions Description: MLH ALL METAL PRESS SENSE -ATF In stock: Out stock</p> <p>RFQ</p>	 <p>MLH250BSD14E Manufacturers: Honeywell Sensing and Productivity Solutions Description: SENSOR SEALED GAUGE 0-250 BAR In stock: Out stock</p> <p>RFQ</p>
 <p>MLH250BSG02B Manufacturers: Honeywell Sensing and Productivity Solutions Description: MLH ALL METAL PRESS SENSE -ATF In stock: Out stock</p> <p>RFQ</p>	 <p>MLH250BSD01B Manufacturers: Honeywell Sensing and Productivity Solutions Description: SENSOR AMP 250BAR 4-20MA OUT In stock: 37 pcs</p> <p>RFQ</p>
 <p>MLH250BSB02A Manufacturers: Honeywell Sensing and Productivity Solutions Description: MLH ALL METAL PRESS SENSE -ATF In stock: Out stock</p> <p>RFQ</p>	 <p>MLH250BSB14D Manufacturers: Honeywell Sensing and Productivity Solutions Description: MLH ALL METAL PRESS SENSE -ATF In stock: Out stock</p> <p>RFQ</p>
 <p>MLH250BSB10A Manufacturers: Honeywell Sensing and Productivity Solutions Description: MLH ALL METAL PRESS SENSE -ATF In stock: Out stock</p> <p>RFQ</p>	 <p>MLH250BSD14A Manufacturers: Honeywell Sensing and Productivity Solutions Description: SENSOR SEALED GAUGE 0-250 BAR In stock: Out stock</p> <p>RFQ</p>
 <p>MLH250BSC17D Manufacturers: Honeywell Sensing and Productivity Solutions Description: MLH ALL METAL PRESS SENSE -ATF In stock: Out stock</p> <p>RFQ</p>	 <p>MLH250BSD14B Manufacturers: Honeywell Sensing and Productivity Solutions Description: SENSOR SEALED GAUGE 0-250 BAR In stock: Out stock</p> <p>RFQ</p>