



Agastat Relays / TE Connectivity

G-MRCO-006

Part Number:

G-MRCO-006

Manufacturer/Brand:

Agastat Relays / TE Connectivity

Product description:

SENSOR LINEAR ANALOG SOT223

Datasheets:

 G-MRCO-006.pdf

RoHS Status:

 Lead free / RoHS Compliant

Ship From:

Hong Kong

Shipment Way:

DHL/Fedex/TNT/UPS/EMS

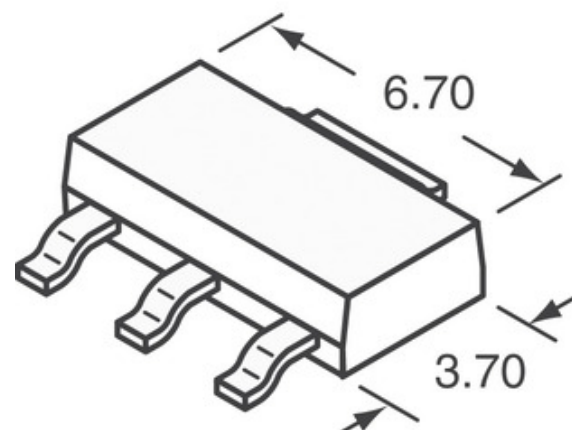



Image may be representation. See specifications for product details.

[REQUEST FOR QUOTATION](#)









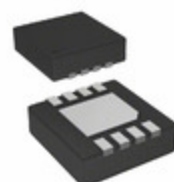

Specifications of G-MRCO-006

PART NUMBER	G-MRCO-006
MANUFACTURER	Agastat Relays / TE Connectivity
DESCRIPTION	SENSOR LINEAR ANALOG SOT223
LEAD FREE STATUS / ROHS STATUS	Lead free / RoHS Compliant
DATA SHEET	 G-MRCO-006.pdf
VOLTAGE - SUPPLY	5V
TECHNOLOGY	Magnetostrictive
SUPPLIER DEVICE PACKAGE	SOT-223
SERIES	-
SENSING RANGE	-
RESOLUTION	-
PACKAGING	Cut Tape (CT)
PACKAGE / CASE	TO-261-4, TO-261AA
OUTPUT TYPE	Analog Voltage
OTHER NAMES	356-1078-1
OPERATING TEMPERATURE	-40°C ~ 150°C (TA)
MOISTURE SENSITIVITY LEVEL (MSL)	1 (Unlimited)
LEAD FREE STATUS / ROHS STATUS	Lead free / RoHS Compliant
FEATURES	-
DETAILED DESCRIPTION	Magnetostrictive Sensor Single Axis SOT-223
CURRENT - SUPPLY (MAX)	9mA
CURRENT - OUTPUT (MAX)	-
BANDWIDTH	-
AXIS	Single

Related Tags

Agastat Relays / TE Connectivity G-MRCO-006	G-MRCO-006 Distributor	G-MRCO-006 Supplier
G-MRCO-006 Price	G-MRCO-006 Pictures	G-MRCO-006 Image
G-MRCO-006 PDF Datasheet	G-MRCO-006 Download Datasheet	G-MRCO-006 Datasheet
G-MRCO-006 Stock	Buy G-MRCO-006	Buy Agastat Relays / TE Connectivity G-MRCO-006
Agastat Relays / TE Connectivity G-MRCO-006	Agastat Relays / TE Connectivity Supplier	Agastat Relays / TE Connectivity Distributor
Agastat Relays / TE Connectivity G-MRCO-006	Axicom Relays / TE Connectivity G-MRCO-006	Buchanan Terminal Blocks / TE Connectivity G-MRCO-006
CGS Resistors / TE Connectivity G-MRCO-006	CII / TE Connectivity G-MRCO-006	Elcon Connectors / TE Connectivity G-MRCO-006
Holsworthy Resistors / TE Connectivity G-MRCO-006	Kilovac Relays / TE Connectivity G-MRCO-006	Neohm Resistors / TE Connectivity G-MRCO-006
OEG Relays / TE Connectivity G-MRCO-006	Products Unlimited Transformers & Relays / TE Conn G-MRCO-006	Q-Cee's / TE Connectivity G-MRCO-006
Schrack Relays / TE Connectivity G-MRCO-006	Sigma Inductors / TE Connectivity G-MRCO-006	TE Connectivity's Agastat Relays G-MRCO-006
TE Connectivity's Axicom Relays G-MRCO-006	TE Connectivity's Buchanan Terminal Blocks G-MRCO-006	TE Connectivity's CGS Resistors G-MRCO-006
TE Connectivity's CII G-MRCO-006	TE Connectivity's Elcon Connectors G-MRCO-006	TE Connectivity's Holsworthy Resistors G-MRCO-006
TE Connectivity's Neohm Resistors G-MRCO-006	TE Connectivity's OEG Relays G-MRCO-006	TE Connectivity's Q-Cee's G-MRCO-006
TE Connectivity's Schrack Relays G-MRCO-006	TE Connectivity's Sigma Inductors G-MRCO-006	TE Connectivity's Products Unlimited Transformers G-MRCO-006
TE Connectivity's Kilovac Relays G-MRCO-006		

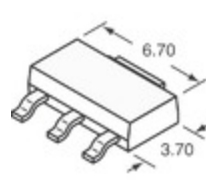
Related Products

 <p>G-MRCO-021 Manufacturers: Agastat Relays / TE Connectivity Description: SENSOR ANGLE 360DEG SMD In stock: 5271 pcs</p> <p>RFQ</p>	 <p>HAL825UT-A Manufacturers: Micronas Description: TO92-UT In stock: 69931 pcs</p> <p>RFQ</p>
 <p>G-MRCO-017 Manufacturers: Agastat Relays / TE Connectivity Description: SENSOR LINEAR ANALOG 8TDFN In stock: 81969 pcs</p> <p>RFQ</p>	 <p>G-MRCO-003 Manufacturers: Agastat Relays / TE Connectivity Description: SENSOR LINEAR ANALOG 4SIP In stock: 22103 pcs</p> <p>RFQ</p>
 <p>G-MRCO-016 Manufacturers: Agastat Relays / TE Connectivity Description: SENSOR ANGLE 180DEG SMD In stock: 91822 pcs</p> <p>RFQ</p>	 <p>G-MRCO-028 Manufacturers: Agastat Relays / TE Connectivity Description: SENSOR 4SIP In stock: 46507 pcs</p> <p>RFQ</p>
 <p>MLX90333EGO-BCT-000-RE Manufacturers: Melexis Description: SENSOR LINEAR ANALOG/PWM 16TSSOP In stock: 13455 pcs</p> <p>RFQ</p>	 <p>G-MRCO-014 Manufacturers: Agastat Relays / TE Connectivity Description: SENSOR ANGLE 180DEG SMD In stock: 44274 pcs</p> <p>RFQ</p>
 <p>G-MRCO-037 Manufacturers: Agastat Relays / TE Connectivity Description: SENSOR ANGLE SMD In stock: 93239 pcs</p> <p>RFQ</p>	 <p>G-MRCO-001 Manufacturers: Agastat Relays / TE Connectivity Description: SENSOR LINEAR ANALOG SOT223 In stock: 40130 pcs</p> <p>RFQ</p>
 <p>G-MRMO-031 Manufacturers: Agastat Relays / TE Connectivity Description: SENSOR LINEAR I2C/PWM 20TSSOP In stock: 13534 pcs</p> <p>RFQ</p>	 <p>G-MRCO-011 Manufacturers: Agastat Relays / TE Connectivity Description: SENSOR LINEAR ANALOG SOT223 In stock: 33998 pcs</p> <p>RFQ</p>

