

Panasonic

Panasonic

JS1A-F-24V-F

Part Number: JS1A-F-24V-F
 Manufacturer/Brand: Panasonic
 Product description: RELAY GEN PURPOSE SPST 10A 24V
 Datasheets: [PDF JS1A-F-24V-F.pdf](#)
 RoHS Status:  Lead free / RoHS Compliant
 Ship From: Hong Kong
 Shipment Way: DHL/Fedex/TNT/UPS/EMS

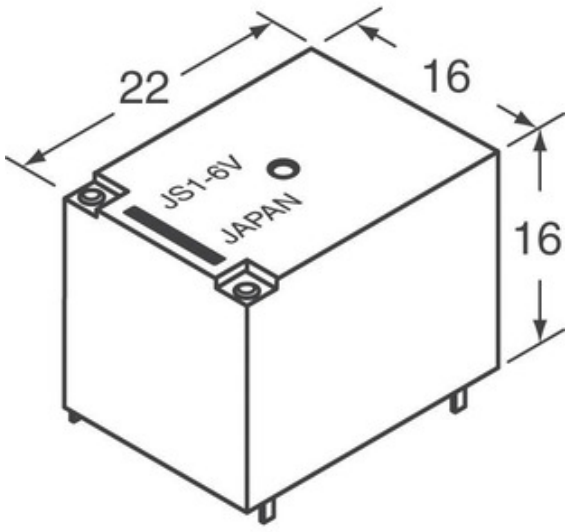

[REQUEST FOR QUOTATION](#)

Image may be representation. See specifications for product details.





Specifications of JS1A-F-24V-F

PART NUMBER	JS1A-F-24V-F
MANUFACTURER	Panasonic
DESCRIPTION	RELAY GEN PURPOSE SPST 10A 24V
LEAD FREE STATUS / ROHS STATUS	Lead free / RoHS Compliant
DATA SHEET	PDF JS1A-F-24V-F.pdf
TURN ON VOLTAGE (MAX)	16.8 VDC
TURN OFF VOLTAGE (MIN)	2.4 VDC
TERMINATION STYLE	PC Pin
SWITCHING VOLTAGE	250VAC, 100VDC - Max
SERIES	JS
RELEASE TIME	10ms
RELAY TYPE	General Purpose
PACKAGING	Bulk
OPERATING TEMPERATURE	-40°C ~ 105°C
OPERATE TIME	10ms
MOUNTING TYPE	Through Hole
MOISTURE SENSITIVITY LEVEL (MSL)	1 (Unlimited)
MANUFACTURER STANDARD LEAD TIME	16 Weeks
LEAD FREE STATUS / ROHS STATUS	Lead free / RoHS Compliant
FEATURES	Insulation - Class F, Sealed - Fully
DETAILED DESCRIPTION	General Purpose Relay SPST-NO (1 Form A) 24VDC Coil Through Hole
CONTACT RATING (CURRENT)	10A
CONTACT MATERIAL	Silver Tin Oxide (AgSnO)
CONTACT FORM	SPST-NO (1 Form A)
COIL VOLTAGE	24VDC
COIL TYPE	Non Latching
COIL RESISTANCE	1.6 kOhms
COIL POWER	360 mW
COIL CURRENT	15.0mA

Related Tags

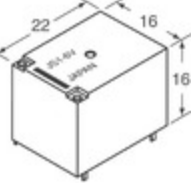
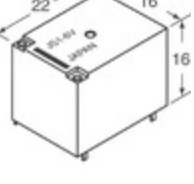
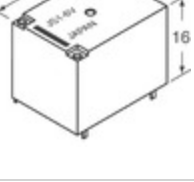
Panasonic JS1A-F-24V-F	JS1A-F-24V-F Distributor	JS1A-F-24V-F Supplier
JS1A-F-24V-F Price	JS1A-F-24V-F Pictures	JS1A-F-24V-F Image
JS1A-F-24V-F PDF Datasheet	JS1A-F-24V-F Download Datasheet	JS1A-F-24V-F Datasheet
JS1A-F-24V-F Stock	Buy JS1A-F-24V-F	Buy Panasonic JS1A-F-24V-F
Panasonic JS1A-F-24V-F	Panasonic Supplier	Panasonic Distributor
Panasonic JS1A-F-24V-F	Panasonic - Consumer Division JS1A-F-24V-F	Panasonic - Consumer Electronics Corp. JS1A-F-24V-F
Panasonic Battery Group JS1A-F-24V-F	Panasonic Electric Works - ACSD JS1A-F-24V-F	Panasonic Electronic Components - Semiconductor Pr JS1A-F-24V-F
Panasonic - ATG JS1A-F-24V-F	Panasonic - BSG JS1A-F-24V-F	Panasonic - DTG JS1A-F-24V-F
Panasonic Electric Works JS1A-F-24V-F	Panasonic Electronic Components JS1A-F-24V-F	Panasonic Industrial Automation Sales JS1A-F-24V-F
Panasonic Semiconductor JS1A-F-24V-F		

Related Products

 <p>JS1A-F-5V-F Manufacturers: Panasonic Description: RELAY GEN PURPOSE SPST 10A 5V In stock: Out stock RFQ</p>	 <p>JS1A-F-12V-F Manufacturers: Panasonic Description: RELAY GEN PURPOSE SPST 10A 12V In stock: Out stock RFQ</p>
 <p>JS1A-B-6V-F Manufacturers: Panasonic Description: RELAY GEN PURPOSE SPST 10A 6V In stock: 100 pcs RFQ</p>	 <p>JS1A-F-12V-F-6K Manufacturers: Panasonic Description: RELAY GEN PURPOSE SPST 10A 12V In stock: Out stock RFQ</p>
 <p>JS1A-F-9V-F Manufacturers: Panasonic Description: RELAY GEN PURPOSE SPST 10A 9V In stock: Out stock RFQ</p>	 <p>JS1A-B-9V Manufacturers: Panasonic Description: RELAY GEN PURPOSE SPST 10A 9V In stock: Out stock RFQ</p>
 <p>JS1A-F-48V-F Manufacturers: Panasonic Description: RELAY GEN PURPOSE SPST 10A 48V In stock: Out stock RFQ</p>	 <p>JS1A-B-9V-F Manufacturers: Panasonic Description: RELAY GEN PURPOSE SPST 10A 9V In stock: 39 pcs RFQ</p>
 <p>JS1A-F-6V-F Manufacturers: Panasonic Description: RELAY GEN PURPOSE SPST 10A 6V In stock: Out stock RFQ</p>	 <p>JS1AF-12V-F Manufacturers: Panasonic Description: RELAY GEN PURPOSE SPST 10A 12V In stock: Out stock RFQ</p>
 <p>JS1AF-12V Manufacturers: Panasonic Description: RELAY GEN PURPOSE SPST 10A 12V In stock: Out stock RFQ</p>	 <p>JS1A-F-18V-F Manufacturers: Panasonic Description: RELAY GEN PURPOSE SPST 10A 18V In stock: Out stock RFQ</p>

