



Panasonic

Panasonic

ARXP1012

Part Number:	ARXP1012
Manufacturer/Brand:	Panasonic
Product description:	RELAY RF SPDT 500MA 12V
Datasheets:	 ARXP1012.pdf
RoHS Status:	 Lead free / RoHS Compliant
Ship From:	Hong Kong
Shipment Way:	DHL/Fedex/TNT/UPS/EMS

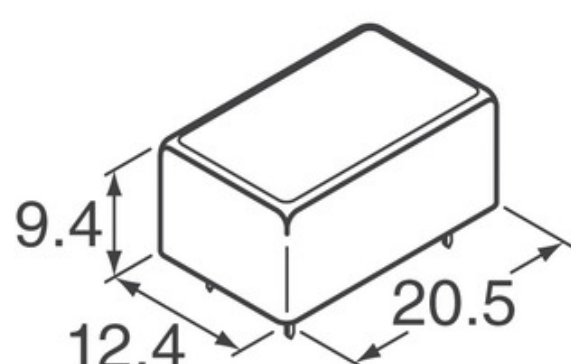



Image may be representation. See specifications for product details.

[REQUEST FOR QUOTATION](#)













Specifications of ARXP1012

PART NUMBER	ARXP1012
MANUFACTURER	Panasonic
DESCRIPTION	RELAY RF SPDT 500MA 12V
LEAD FREE STATUS / ROHS STATUS	Lead free / RoHS Compliant
DATA SHEET	 ARXP1012.pdf
TURN ON VOLTAGE (MAX)	9 VDC
TURN OFF VOLTAGE (MIN)	1.2 VDC
TERMINATION STYLE	PC Pin
SWITCHING VOLTAGE	30VDC - Max
SERIES	ARXP
RELEASE TIME	6ms
PACKAGING	Tube
OTHER NAMES	255-2719
OPERATING TEMPERATURE	-40°C ~ 70°C
OPERATE TIME	10ms
MOUNTING TYPE	Through Hole
MOISTURE SENSITIVITY LEVEL (MSL)	1 (Unlimited)
LEAD FREE STATUS / ROHS STATUS	Lead free / RoHS Compliant
FEATURES	-
CONTACT RATING (CURRENT)	500mA
CONTACT MATERIAL	Gold Plating
CONTACT FORM	SPDT (1 Form C)
COIL VOLTAGE	12VDC
COIL TYPE	Non Latching
COIL RESISTANCE	720 Ohms
COIL POWER	200 mW
COIL CURRENT	16.7mA

Related Tags

Panasonic ARXP1012	ARXP1012 Distributor	ARXP1012 Supplier
ARXP1012 Price	ARXP1012 Pictures	ARXP1012 Image
ARXP1012 PDF Datasheet	ARXP1012 Download Datasheet	ARXP1012 Datasheet
ARXP1012 Stock	Buy ARXP1012	Buy Panasonic ARXP1012
Panasonic ARXP1012	Panasonic Supplier	Panasonic Distributor
Panasonic ARXP1012	Panasonic - Consumer Division ARXP1012	Panasonic - Consumer Electronics Corp. ARXP1012
Panasonic Battery Group ARXP1012	Panasonic Electric Works - ACSD ARXP1012	Panasonic Electronic Components - Semiconductor Pr ARXP1012
Panasonic - ATG ARXP1012	Panasonic - BSG ARXP1012	Panasonic - DTG ARXP1012
Panasonic Electric Works ARXP1012	Panasonic Electronic Components ARXP1012	Panasonic Industrial Automation Sales ARXP1012
Panasonic Semiconductor ARXP1012		

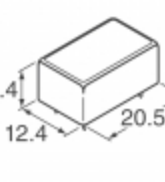
Related Products

 <p>ARXP1103 Manufacturers: Panasonic Description: RELAY RF SPDT 500MA 3V In stock: Out stock</p> <p>RFQ</p>	 <p>ARX550AT2R00XPEAH-GEVB Manufacturers: AMI Semiconductor / ON Semiconductor Description: BOARD EVAL WVGA 1/4" CIS HB In stock: Out stock</p> <p>RFQ</p>
 <p>ARX550HDSC00XPEA0-DRBR1 Manufacturers: AMI Semiconductor / ON Semiconductor Description: IMAGE SENSOR VGA 1/5 CIS In stock: Out stock</p> <p>RFQ</p>	 <p>ARXP1112 Manufacturers: Panasonic Description: RELAY RF SPDT 500MA 12V In stock: Out stock</p> <p>RFQ</p>
 <p>ARXP1006 Manufacturers: Panasonic Description: RELAY RF SPDT 500MA 6V In stock: Out stock</p> <p>RFQ</p>	 <p>ARX550HDSC00XPEAH-GEVB Manufacturers: AMI Semiconductor / ON Semiconductor Description: BOARD EVAL VGA 1/5" CIS HB In stock: Out stock</p> <p>RFQ</p>
 <p>ARXP1024 Manufacturers: Panasonic Description: RELAY RF SPDT 500MA 24V In stock: Out stock</p> <p>RFQ</p>	 <p>ARXP1106 Manufacturers: Panasonic Description: RELAY RF SPDT 500MA 6V In stock: Out stock</p> <p>RFQ</p>
 <p>ARXP1109 Manufacturers: Panasonic Description: RELAY RF SPDT 500MA 9V In stock: Out stock</p> <p>RFQ</p>	 <p>ARXP1009 Manufacturers: Panasonic Description: RELAY RF SPDT 500MA 9V In stock: Out stock</p> <p>RFQ</p>
 <p>ARXP1003 Manufacturers: Panasonic Description: RELAY RF SPDT 500MA 3V In stock: Out stock</p> <p>RFQ</p>	 <p>ARXP104H Manufacturers: Panasonic Description: RELAY RF SPDT 500MA 4.5V In stock: Out stock</p> <p>RFQ</p>