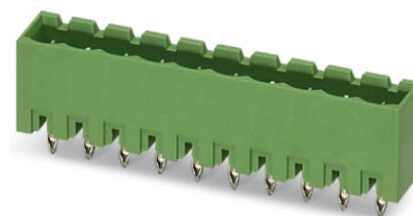

EMSTBVA 2,5/ 9-G-5,08

Order No.: 1859580

The figure shows a 10-position version of the product

<http://eshop.phoenixcontact.de/phoenix/treeViewClick.do?UID=1859580>Header, Nominal current: 12 A, Nom. voltage: 200 V, Pitch: 5.08 mm,
Number of positions: 9, Color: green, Assembly: Press-in

Commercial data

EAN	4017918133009
Pack	50 pcs.
Customs tariff	85366990
Weight/Piece	0.0041 KG
Catalog page information	Page 247 (CC-2009)

Product notes

WEEE/RoHS-compliant since:
01/01/2003

<http://www.download.phoenixcontact.com>
Please note that the data given here has been taken from the online catalog. For comprehensive information and data, please refer to the user documentation. The General Terms and Conditions of Use apply to Internet downloads.

Technical data

Dimensions / positions

Length	8.6 mm
Pitch	5.08 mm
Dimension a	40.64 mm
Number of positions	9
Pin dimensions	1,7 mm

Hole diameter	1.75 mm
Technical data	
Insulating material group	IIIa
Rated surge voltage (III/3)	4 kV
Rated surge voltage (III/2)	4 kV
Rated surge voltage (II/2)	4 kV
Rated voltage (III/2)	320 V
Rated voltage (II/2)	320 V
Connection in acc. with standard	EN-VDE
Nominal current I_N	12 A
Nominal voltage U_N	200 V
Maximum load current	12 A
Insulating material	PBT
Inflammability class acc. to UL 94	V0

Certificates / Approvals



Certification CB, CUL, GOST, UL, VDE-PZI

CUL

Nominal voltage U_N	300 V
Nominal current I_N	10 A

UL

Nominal voltage U_N	300 V
Nominal current I_N	10 A

Accessories

Item	Designation	Description
Assembly		
1877203	EMSTB 2,5-SH	Stamp holder, for upper and lower stamp
1877216	EMSTBVA 2,5-SS-1-5,08	Stamp set, consisting of an upper and lower stamp, upper stamp: 2 to 16-pos., lower stamp: 2 to 24-pos., pitch: 5.08 mm

1877229	EMSTBVA 2,5-SS-2-5,08	Stamp set, consisting of an upper and lower stamp, upper stamp: 17 to 24-pos., lower stamp: 2 to 24-pos., pitch: 5.08 mm
1755477	MSTB-BL	Keying cap, for forming sections, plugs onto header pin, green insulating material

Marking

0804293	SK 5,08/3,8:FORTL.ZAHLEN	Marker card, printed horizontally, self-adhesive, 12 identical decades marked 1-10, 11-20 etc. up to 91-(99)100, sufficient for 120 terminal blocks
---------	--------------------------	---

Plug/Adapter

1734401	CR-MSTB	Coding section, inserted into the recess in the header or the inverted plug, red insulating material
---------	---------	--

Additional products

Item	Designation	Description
General		
1872761	A-ICV 2,5/ 9-G-5,08	Base strip, Nominal current: 12 A, Nominal voltage: 250 V, Mounting type: DIN rail mounting, Number of positions: 9, Pitch: 5.08 mm, Color: green
1873126	FKC 2,5/ 9-ST-5,08	Plug component, Nominal current: 12 A, Nom. voltage: 250 V, Pitch: 5.08 mm, Number of positions: 9, Connection type: Spring-cage conn., Color: green
1902181	FKCT 2,5/ 9-ST-5,08	Plug component, Nominal current: 12 A, Nom. voltage: 250 V, Pitch: 5.08 mm, Number of positions: 9, Connection type: Spring-cage conn., Color: green
1874028	FKCVR 2,5/ 9-ST-5,08	Plug component, Nominal current: 12 A, Nom. voltage: 250 V, Pitch: 5.08 mm, Number of positions: 9, Connection type: Spring-cage conn., Color: green
1873728	FKCVW 2,5/ 9-ST-5,08	Plug component, Nominal current: 12 A, Nom. voltage: 250 V, Pitch: 5.08 mm, Number of positions: 9, Connection type: Spring-cage conn., Color: green
1777358	FRONT-MSTB 2,5/ 9-ST-5,08	Plug component, Nominal current: 12 A, Nom. voltage: 250 V, Pitch: 5.08 mm, Number of positions: 9, Connection type: Screw connection, Color: green
1786475	IC 2,5/ 9-G-5,08	Header, Nominal current: 12 A, Nom. voltage: 320 V, Pitch: 5.08 mm, Number of positions: 9, Color: green, Assembly: Soldering
1786019	ICV 2,5/ 9-G-5,08	Header, Nominal current: 12 A, Nom. voltage: 320 V, Pitch: 5.08 mm, Number of positions: 9, Color: green, Assembly: Soldering
1757080	MSTB 2,5/ 9-ST-5,08	Plug component, Nominal current: 12 A, Nom. voltage: 250 V, Pitch: 5.08 mm, Number of positions: 9, Connection type: Screw connection, Color: green

1764316	MSTB 2,5/ 9-STZ-5,08	Plug component, Nominal current: 12 A, Nom. voltage: 250 V, Pitch: 5.08 mm, Number of positions: 9, Connection type: Screw connection, Color: green
1808887	MSTBC 2,5/ 9-ST-5,08	Plug component, Nominal current: 12 A, Nom. voltage: 320 V, Pitch: 5.08 mm, Number of positions: 9, Connection type: Crimp connection, Color: green
1809572	MSTBC 2,5/ 9-STZ-5,08	Plug component, Nominal current: 12 A, Nom. voltage: 320 V, Pitch: 5.08 mm, Number of positions: 9, Connection type: Crimp connection, Color: green
1769081	MSTBP 2,5/ 9-ST-5,08	Plug component, Nominal current: 12 A, Nom. voltage: 250 V, Pitch: 5.08 mm, Number of positions: 9, Connection type: Screw connection, Color: green
1734207	MSTBT 2,5/ 9-ST-5,08	Plug component, Nominal current: 12 A, Nom. voltage: 250 V, Pitch: 5.08 mm, Number of positions: 9, Connection type: Screw connection, Color: green
1824191	MSTBU 2,5/ 9-STD-5,08	Plug component, Nominal current: 12 A, Nom. voltage: 320 V, Pitch: 5.08 mm, Number of positions: 9, Connection type: Screw connection, Assembly: Direct mounting, Color: green
1831388	MSTBVK 2,5/ 9-ST-5,08	Plug component, Nominal current: 12 A, Nom. voltage: 320 V, Pitch: 5.08 mm, Number of positions: 9, Connection type: Screw connection, Assembly: DIN rail, Color: green
1792317	MVSTBR 2,5/ 9-ST-5,08	Plug component, Nominal current: 12 A, Nom. voltage: 250 V, Pitch: 5.08 mm, Number of positions: 9, Connection type: Screw connection, Color: green
1792825	MVSTBW 2,5/ 9-ST-5,08	Plug component, Nominal current: 12 A, Nom. voltage: 250 V, Pitch: 5.08 mm, Number of positions: 9, Connection type: Screw connection, Color: green
1883323	QC 1/ 9-ST-5,08	Plug component, Nominal current: 10 A, Nom. voltage: 500 V, Pitch: 5.08 mm, Number of positions: 9, Connection type: Insulation displacement connection QUICKON, Color: green
1826351	SMSTB 2,5/ 9-ST-5,08	Plug component, Nominal current: 12 A, Nom. voltage: 250 V, Pitch: 5.08 mm, Number of positions: 9, Connection type: Screw connection, Color: green
1853081	TMSTBP 2,5/ 9-ST-5,08	Plug component, Nominal current: 12 A, Nom. voltage: 250 V, Pitch: 5.08 mm, Number of positions: 9, Connection type: Screw connection, Color: green
1833881	UMSTBVK 2,5/ 9-ST-5,08	Plug component, Nominal current: 12 A, Nom. voltage: 320 V, Pitch: 5.08 mm, Number of positions: 9, Connection type: Screw connection, Assembly: DIN rail, Color: green

Diagrams/Drawings

Drilling plan/solder pad geometry

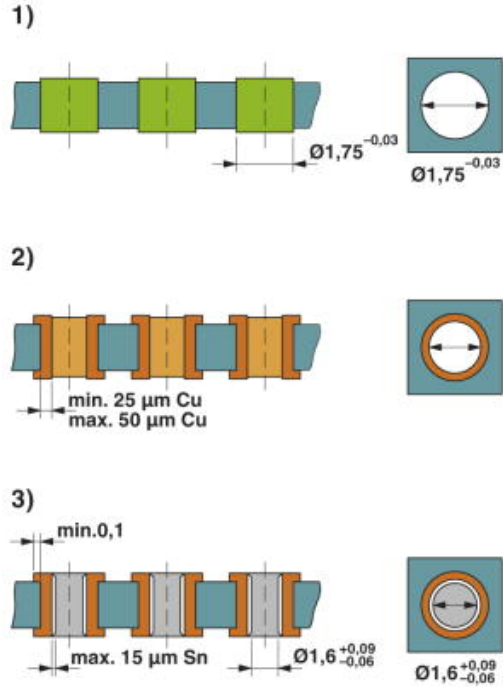
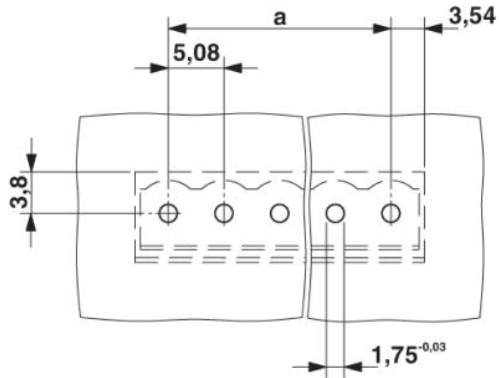

Bohrlochaufbau im Basismaterial FR4 oder EP-GC

Address

PHOENIX CONTACT Deutschland GmbH
Flachmarktstr. 8
32825 Blomberg, Germany
Phone +49 5235 3 12000
Fax +49 5235 3 41200
<http://www.phoenixcontact.de>



© 2010 Phoenix Contact
Technical modifications reserved;