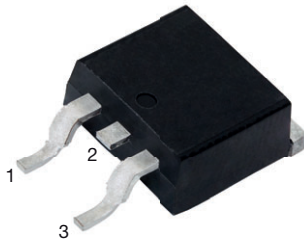
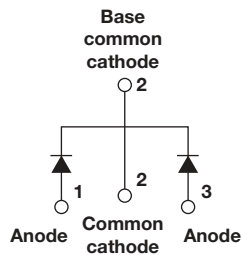

HEXFRED®

Ultrafast Soft Recovery Diode, 2 x 8 A

D²PAK (TO-263AB)

FEATURES

- Ultrafast and ultrasoft recovery
- Very low I_{RRM} and Q_{rr}
- Specified at operating conditions
- Meets MSL level 1, per J-STD-020, LF maximum peak of 245 °C
- Material categorization: for definitions of compliance please see www.vishay.com/doc?99912

RoHS
 COMPLIANT
 HALOGEN
FREE
BENEFITS

- Reduced RFI and EMI
- Reduced power loss in diode and switching transistor
- Higher frequency operation
- Reduced snubbing
- Reduced parts count

DESCRIPTION

VS-HFA16TA60CS is a state of the art center tap ultrafast recovery diode. Employing the latest in epitaxial construction and advanced processing techniques it features a superb combination of characteristics which result in performance which is unsurpassed by any rectifier previously available. With basic ratings of 600 V and 8 A per leg continuous current, the VS-HFA16TA60CS is especially well suited for use as the companion diode for IGBTs and MOSFETs. In addition to ultrafast recovery time, the HEXFRED® product line features extremely low values of peak recovery current (I_{RRM}) and does not exhibit any tendency to “snap-off” during the t_b portion of recovery. The HEXFRED features combine to offer designers a rectifier with lower noise and significantly lower switching losses in both the diode and the switching transistor. These HEXFRED advantages can help to significantly reduce snubbing, component count and heatsink sizes. The HEXFRED VS-HFA16TA60CS is ideally suited for applications in power supplies and power conversion systems (such as inverters), motor drives, and many other similar applications where high speed, high efficiency is needed.

PRIMARY CHARACTERISTICS	
$I_{F(AV)}$	2 x 8 A
V_R	600 V
V_F at I_F	1.4 V
t_{rr} typ.	18 ns
T_J max.	150 °C
Package	D²PAK (TO-263AB)
Circuit configuration	Common cathode

ABSOLUTE MAXIMUM RATINGS				
PARAMETER	SYMBOL	TEST CONDITIONS	VALUES	UNITS
Cathode to anode voltage	V_R		600	V
Maximum continuous forward current — per leg per device	I_F	$T_C = 100\text{ °C}$	8 16	A
Single pulse forward current	I_{FSM}		60	
Maximum repetitive forward current	I_{FRM}		24	
Maximum power dissipation	P_D	$T_C = 25\text{ °C}$	36	W
		$T_C = 100\text{ °C}$	14	
Operating junction and storage temperature range	T_J, T_{Stg}		-55 to +150	°C



ELECTRICAL SPECIFICATIONS PER LEG (T _J = 25 °C unless otherwise specified)						
PARAMETER	SYMBOL	TEST CONDITIONS	MIN.	TYP.	MAX.	UNITS
Cathode to anode breakdown voltage	V _{BR}	I _R = 100 μA	600	-	-	V
Maximum forward voltage	V _{FM}	I _F = 8.0 A	-	1.4	1.7	
		I _F = 16 A	-	1.7	2.1	
		I _F = 8.0 A, T _J = 125 °C	-	1.4	1.7	
Maximum reverse leakage current	I _{RM}	V _R = V _R rated	-	0.3	5.0	μA
		T _J = 125 °C, V _R = 0.8 x V _R rated	-	100	500	
Junction capacitance	C _T	V _R = 200 V	-	10	25	pF
Series inductance	L _S	Measured lead to lead 5 mm from package body	-	8.0	-	nH

DYNAMIC RECOVERY CHARACTERISTICS PER LEG (T _J = 25 °C unless otherwise specified)						
PARAMETER	SYMBOL	TEST CONDITIONS	MIN.	TYP.	MAX.	UNITS
Reverse recovery time See fig. 5, 6 and 16	t _{rr}	I _F = 1.0 A, di _F /dt = 200 A/μs, V _R = 30 V	-	18	-	ns
	t _{rr1}	T _J = 25 °C	-	37	55	
	t _{rr2}	T _J = 125 °C	-	55	90	
Peak recovery current See fig. 7 and 8	I _{RRM1}	T _J = 25 °C	-	3.5	5.0	A
	I _{RRM2}	T _J = 125 °C	-	4.5	8.0	
Reverse recovery charge See fig. 9 and 10	Q _{rr1}	T _J = 25 °C	-	65	138	nC
	Q _{rr2}	T _J = 125 °C	-	124	360	
Peak rate of fall of recovery current during t _p , see fig. 11 & 12	di _(rec) /dt1	T _J = 25 °C	-	240	-	A/μs
	di _(rec) /dt2	T _J = 125 °C	-	210	-	

THERMAL - MECHANICAL SPECIFICATIONS						
PARAMETER	SYMBOL	TEST CONDITIONS	MIN.	TYP.	MAX.	UNITS
Lead temperature	T _{lead}	0.063" from case (1.6 mm) for 10 s	-	-	300	°C
Junction to case, single leg conducting	R _{thJC}		-	-	3.5	K/W
Junction to case, both legs conducting			-	-	1.75	
Thermal resistance, junction to ambient	R _{thJA}	Typical socket mount	-	-	80	
Weight			-	2	-	g
			-	0.07	-	oz.
Mounting torque			6.0 (5.0)	-	12 (10)	kgf · cm (lbf · in)
Marking device		Case style D ² PAK (TO-263AB)	HFA16TA60CS			

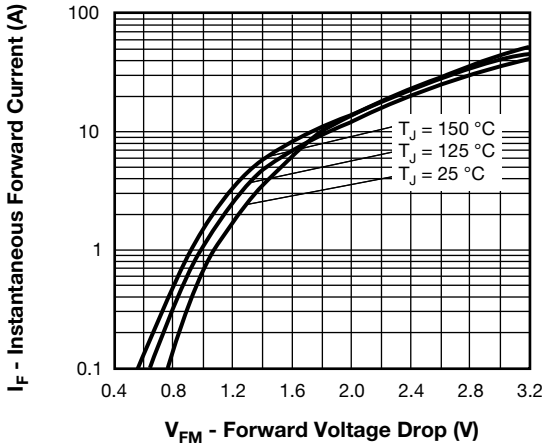

Fig. 1 - Maximum Forward Voltage Drop vs. Instantaneous Forward Current (Per Leg)

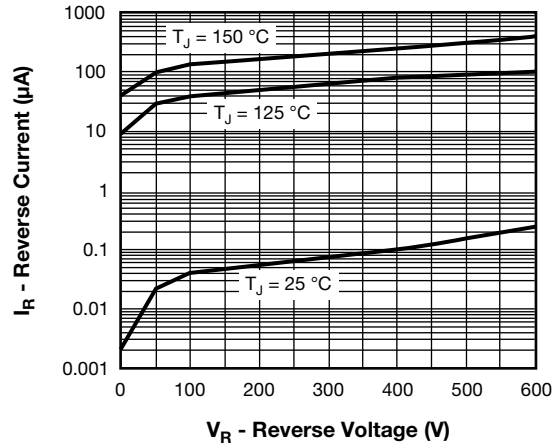

Fig. 2 - Typical Reverse Current vs. Reverse Voltage (Per Leg)

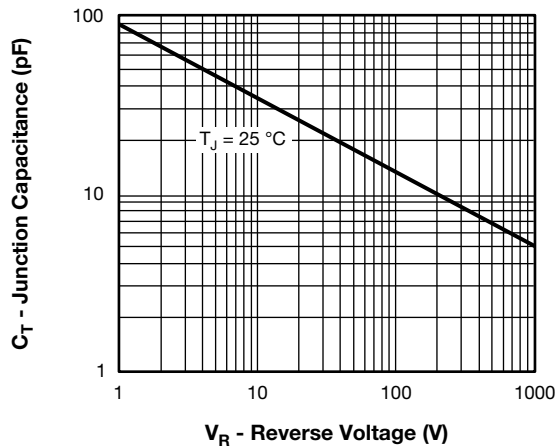

Fig. 3 - Typical Junction Capacitance vs. Reverse Voltage (Per Leg)

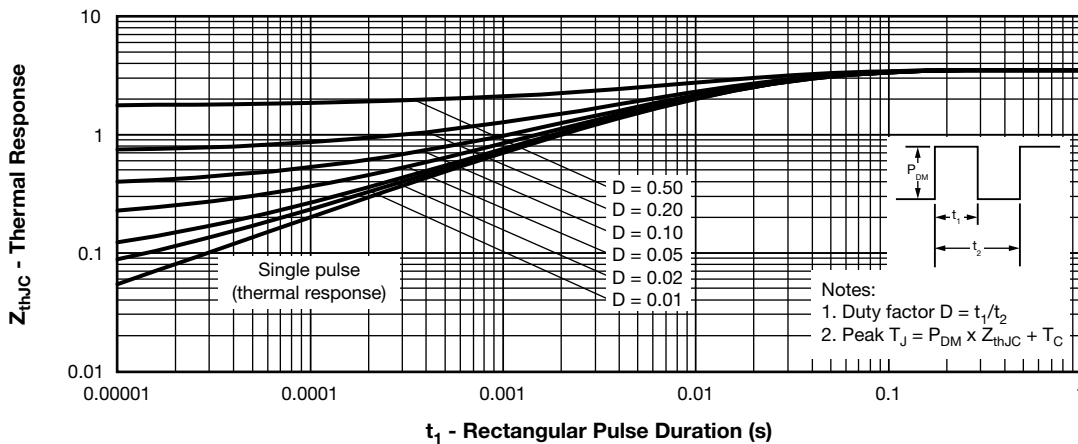

Fig. 4 - Maximum Thermal Impedance Z_{thJC} Characteristics (Per Leg)

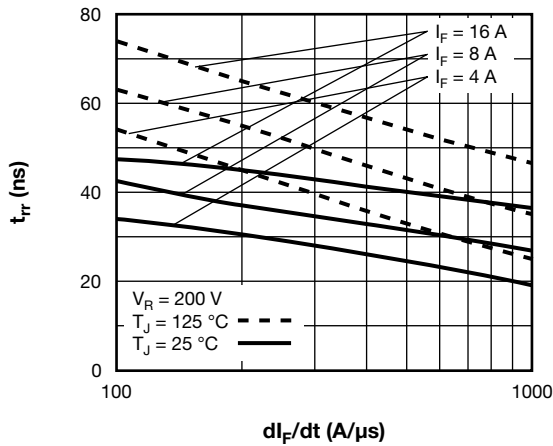

Fig. 5 - Typical Reverse Recovery Time vs. di_F/dt (Per Leg)

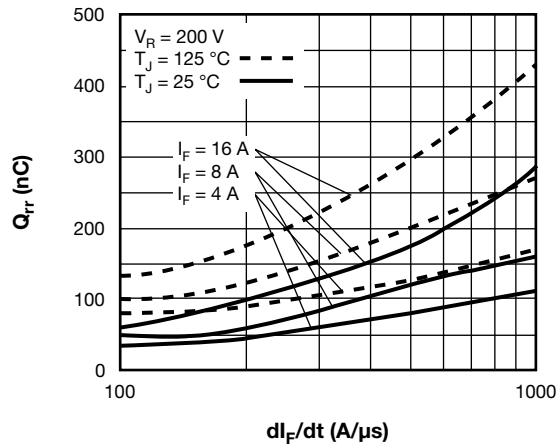

Fig. 7 - Typical Stored Charge vs. di_F/dt (Per Leg)

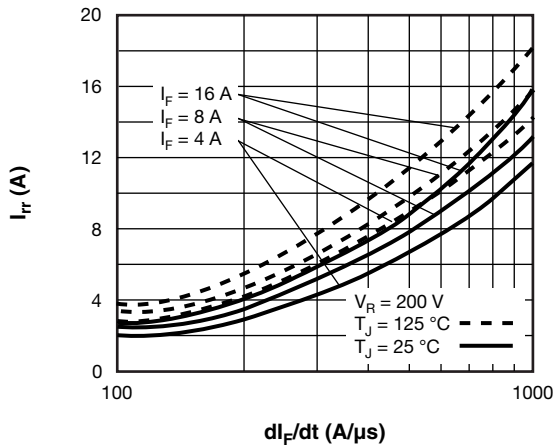

Fig. 6 - Typical Recovery Current vs. di_F/dt (Per Leg)

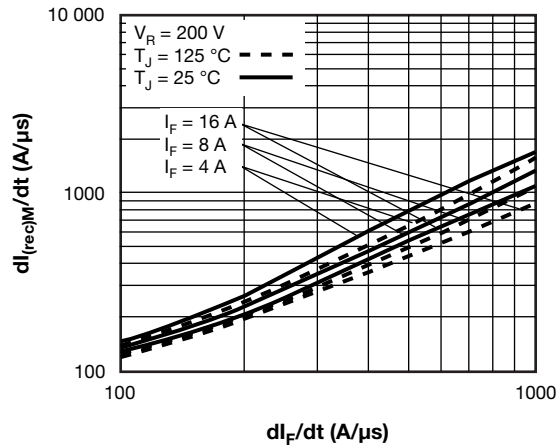
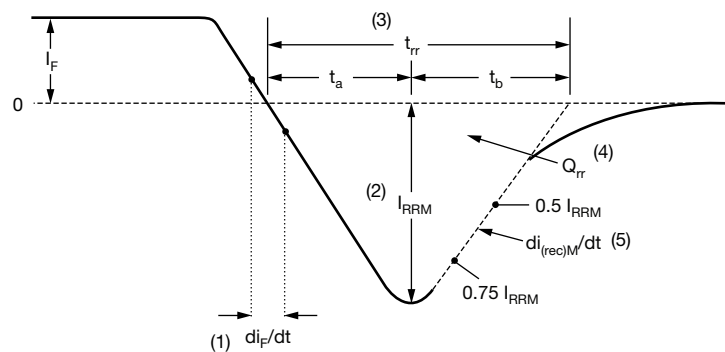

Fig. 8 - Typical $di_{(rec)M}/dt$ vs. di_F/dt (Per Leg)



- (1) di_F/dt - rate of change of current through zero crossing
- (2) I_{RRM} - peak reverse recovery current
- (3) t_{rr} - reverse recovery time measured from zero crossing point of negative going I_F to point where a line passing through $0.75 I_{RRM}$ and $0.50 I_{RRM}$ extrapolated to zero current.
- (4) Q_{rr} - area under curve defined by t_{rr} and I_{RRM}
- (5) $di_{(rec)M}/dt$ - peak rate of change of current during t_b portion of t_{rr}

$$Q_{rr} = \frac{t_{rr} \times I_{RRM}}{2}$$

Fig. 9 - Reverse Recovery Waveform and Definitions



ORDERING INFORMATION TABLE

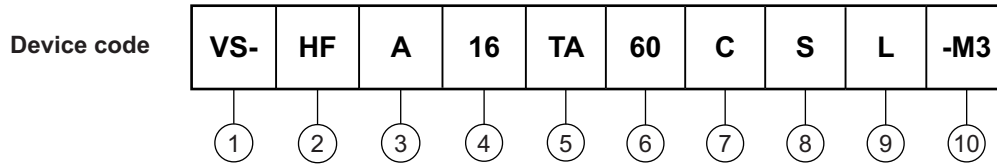

- 1** - Vishay Semiconductors product
- 2** - HEXFRED® family
- 3** - Process designator: A = electron irradiated
- 4** - Current rating (16 = 16 A)
- 5** - Package outline (TA = TO-220, 3 leads)
- 6** - Voltage rating (60 = 600 V)
- 7** - Circuit configuration (C = common cathode)
- 8** - S = D²PAK (TO-263AB)
- 9** -
 - None = tube (50 pieces)
 - L = tape and reel (left oriented)
 - R = tape and reel (right oriented)
- 10** - Environmental digit:
 - M3 = halogen-free, RoHS-compliant, and terminations lead (Pb)-free

ORDERING INFORMATION (Example)			
PREFERRED P/N	QUANTITY PER TUBE	MINIMUM ORDER QUANTITY	PACKAGING DESCRIPTION
VS-HFA16TA60CS-M3	50	1000	Antistatic plastic tube
VS-HFA16TA60CSR-M3	800	800	13" diameter reel
VS-HFA16TA60CSL-M3	800	800	13" diameter reel

LINKS TO RELATED DOCUMENTS	
Dimensions	www.vishay.com/doc?96164
Part marking information	www.vishay.com/doc?95444
Packaging information	www.vishay.com/doc?96424
SPIICE model	www.vishay.com/doc?95689



D²PAK



Example: This is a xxxxxx ⁽¹⁾ with assembly lot code AC, assembled on WW 02, 2010

Note

⁽¹⁾ If part number contain "H" as last digit, product is AEC-Q101 qualified

ENVIRONMENTAL NAMING CODE (Z)	PRODUCT DEFINITION
A	Termination lead (Pb)-free
B	Totally lead (Pb)-free
E	RoHS-compliant and termination lead (Pb)-free
F	RoHS-compliant and totally lead (Pb)-free
M	Halogen-free, RoHS-compliant, and termination lead (Pb)-free
N	Halogen-free, RoHS-compliant, and totally lead (Pb)-free
G	Green

D²PAK

DIMENSIONS in millimeters and inches

Conforms to JEDEC[®] outline D²PAK (SMD-220)

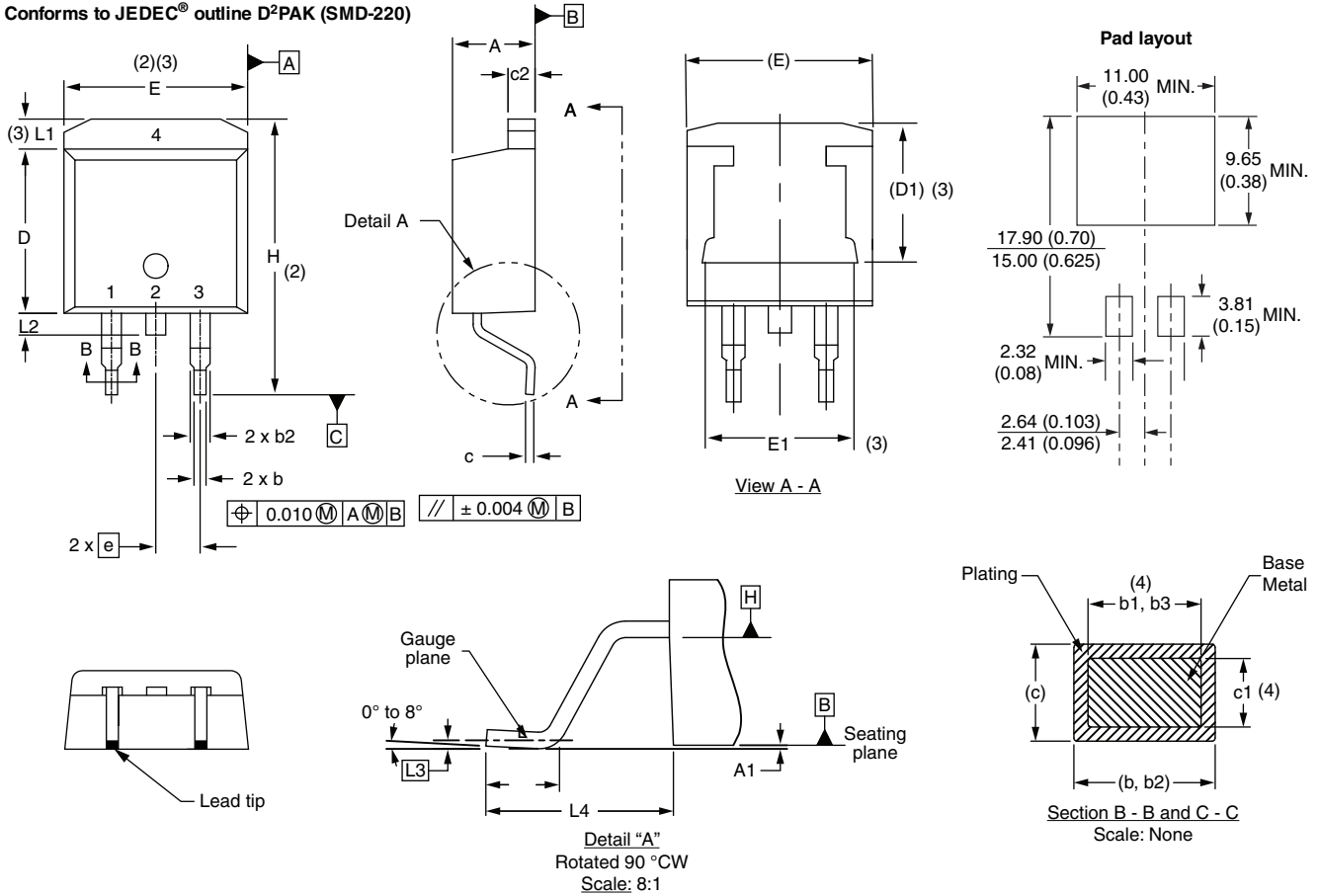

SYMBOL	MILLIMETERS		INCHES		NOTES	SYMBOL	MILLIMETERS		INCHES		NOTES
	MIN.	MAX.	MIN.	MAX.			MIN.	MAX.	MIN.	MAX.	
A	4.06	4.83	0.160	0.190		D1	6.86	8.00	0.270	0.315	3
A1	0.00	0.254	0.000	0.010		E	9.65	10.67	0.380	0.420	2, 3
b	0.51	0.99	0.020	0.039		E1	7.90	8.80	0.311	0.346	3
b1	0.51	0.89	0.020	0.035	4	e	2.54 BSC		0.100 BSC		
b2	1.14	1.78	0.045	0.070		H	14.61	15.88	0.575	0.625	
b3	1.14	1.73	0.045	0.068	4	L	1.78	2.79	0.070	0.110	
c	0.38	0.74	0.015	0.029		L1	-	1.65	-	0.066	3
c1	0.38	0.58	0.015	0.023	4	L2	1.27	1.78	0.050	0.070	
c2	1.14	1.65	0.045	0.065		L3	0.25 BSC		0.010 BSC		
D	8.51	9.65	0.335	0.380	2	L4	4.78	5.28	0.188	0.208	

Notes

- (1) Dimensioning and tolerancing per ASME Y14.5 M-1994
- (2) Dimension D and E do not include mold flash. Mold flash shall not exceed 0.127 mm (0.005") per side. These dimensions are measured at the outmost extremes of the plastic body
- (3) Thermal pad contour optional within dimension E, L1, D1 and E1
- (4) Dimension b1 and c1 apply to base metal only
- (5) Datum A and B to be determined at datum plane H
- (6) Controlling dimension: inches
- (7) Outline conforms to JEDEC[®] outline TO-263AB

D²PAK (TO-263AB)

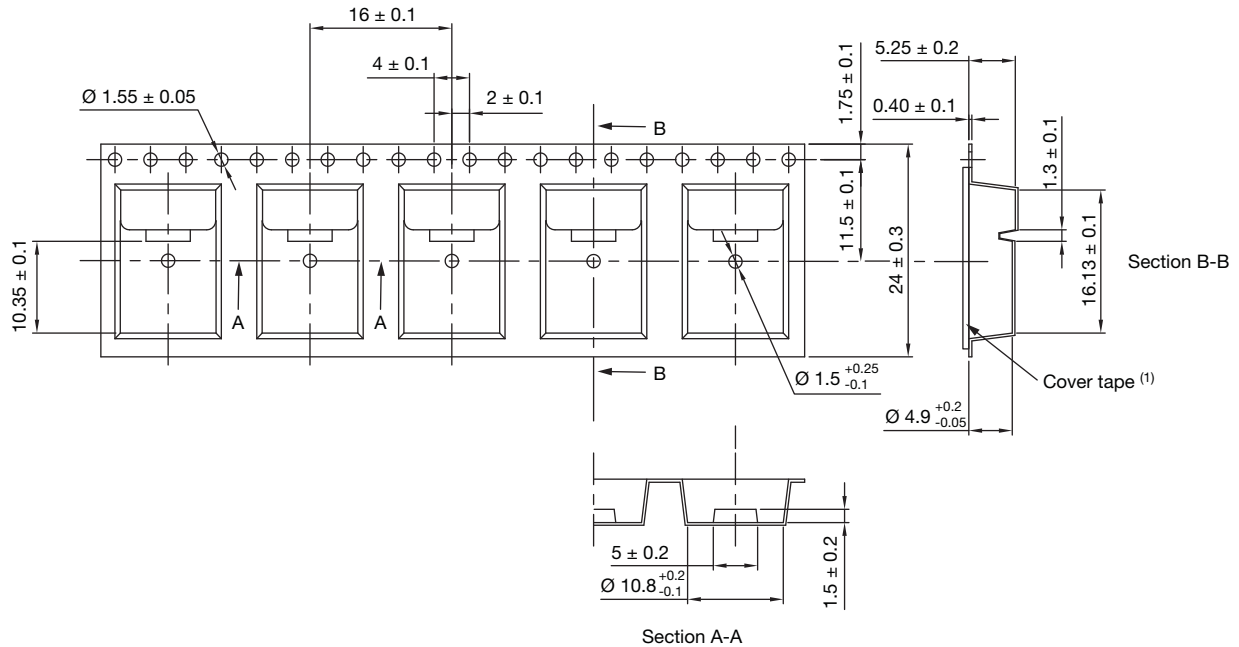
CARRIER TAPE FOR TAPE AND REEL LEFT in millimeters

Note

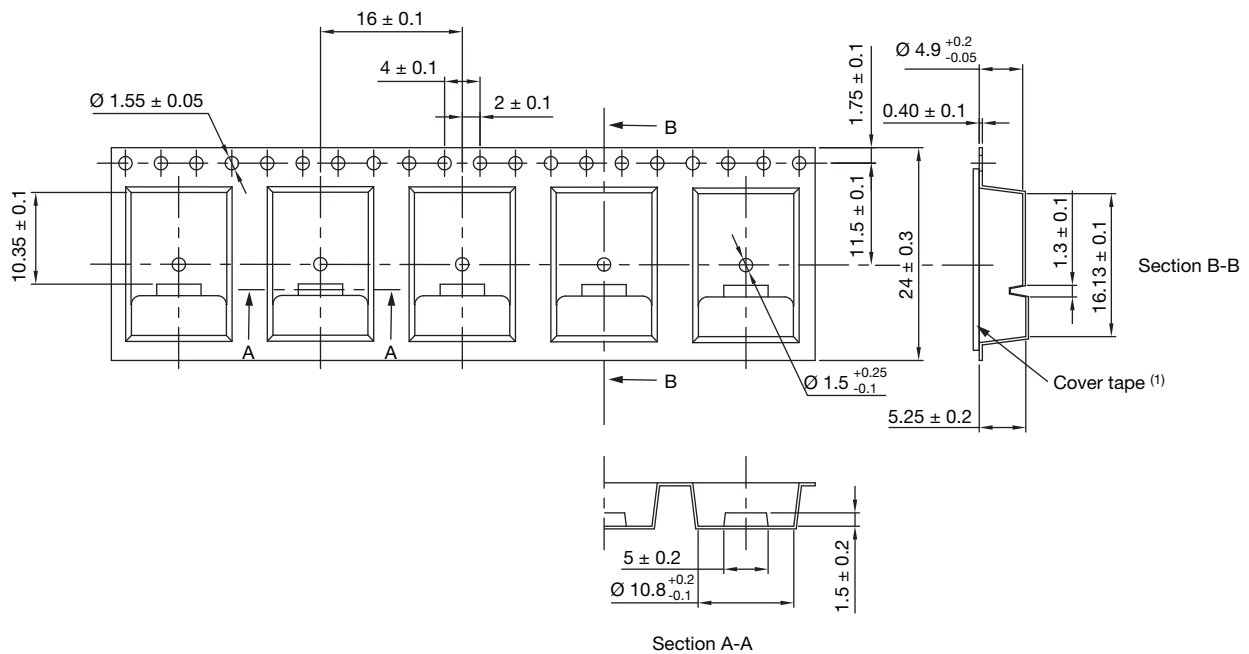
(1) For dimensions, see next pages

CARRIER TAPE FOR TAPE AND REEL RIGHT in millimeters

Note

(1) For dimensions, see next pages



REEL FOR CARRIER TAPE in millimeters



CARRIER TAPE AND REEL PACKAGING D²PAK (TO-263AB)





COVER TAPE FOR CARRIER TAPE in millimeters



APPLICATION	COVER TAPE WIDTH W	COVER TAPE THICKNESS T	CARRIER TAPE WIDTH	MATERIAL
D ² PAK (TO-263AB)	21.3 ± 0.1	0.060 ± 0.01	24	Antistatic/treated/transparent/polyester



Disclaimer

ALL PRODUCT, PRODUCT SPECIFICATIONS AND DATA ARE SUBJECT TO CHANGE WITHOUT NOTICE TO IMPROVE RELIABILITY, FUNCTION OR DESIGN OR OTHERWISE.

Vishay Intertechnology, Inc., its affiliates, agents, and employees, and all persons acting on its or their behalf (collectively, "Vishay"), disclaim any and all liability for any errors, inaccuracies or incompleteness contained in any datasheet or in any other disclosure relating to any product.

Vishay makes no warranty, representation or guarantee regarding the suitability of the products for any particular purpose or the continuing production of any product. To the maximum extent permitted by applicable law, Vishay disclaims (i) any and all liability arising out of the application or use of any product, (ii) any and all liability, including without limitation special, consequential or incidental damages, and (iii) any and all implied warranties, including warranties of fitness for particular purpose, non-infringement and merchantability.

Statements regarding the suitability of products for certain types of applications are based on Vishay's knowledge of typical requirements that are often placed on Vishay products in generic applications. Such statements are not binding statements about the suitability of products for a particular application. It is the customer's responsibility to validate that a particular product with the properties described in the product specification is suitable for use in a particular application. Parameters provided in datasheets and / or specifications may vary in different applications and performance may vary over time. All operating parameters, including typical parameters, must be validated for each customer application by the customer's technical experts. Product specifications do not expand or otherwise modify Vishay's terms and conditions of purchase, including but not limited to the warranty expressed therein.

Except as expressly indicated in writing, Vishay products are not designed for use in medical, life-saving, or life-sustaining applications or for any other application in which the failure of the Vishay product could result in personal injury or death. Customers using or selling Vishay products not expressly indicated for use in such applications do so at their own risk. Please contact authorized Vishay personnel to obtain written terms and conditions regarding products designed for such applications.

No license, express or implied, by estoppel or otherwise, to any intellectual property rights is granted by this document or by any conduct of Vishay. Product names and markings noted herein may be trademarks of their respective owners.