

MAXIM

MAX3996 Evaluation Kit

Evaluates: MAX3996

General Description

The MAX3996 evaluation kit (EV kit) is an assembled demonstration board that provides both optical and electrical evaluation of the MAX3996 2.5Gbps laser driver.

The output of the electrical evaluation section is interfaced to an SMA connector that can be connected to a 50Ω terminated oscilloscope. The output of the optical evaluation section is configured for attachment to a laser/monitor diode.

Features

- ◆ Drives Common-Anode Lasers
- ◆ Fully Assembled and Tested
- ◆ LED Fault Indicator
- ◆ Adjustable Laser Bias Current
- ◆ Adjustable Laser Modulation Current
- ◆ Adjustable Laser Modulation Temperature Coefficient
- ◆ Configured for Electrical Operation; No Laser Necessary

Component Suppliers

SUPPLIER	PHONE	FAX
AVX	803-946-0690	803-626-3123
Coilcraft	847-639-6400	847-639-1469
Murata	814-237-1431	814-238-0490
Zetex	516-543-7100	516-864-7630

Ordering Information

PART	TEMP RANGE	PIN-PACKAGE	TOP MARK
MAX3996EVKIT	0°C to +70°C	20 QFN	—

Component List

DESIGNATION	QTY	DESCRIPTION
C1	1	0.1μF ±10% 10V ceramic capacitor (0402)
C2, C3, C7, C9, C10, C15, C16, C21, C26, C44, C48, C49	12	0.01μF ±10% ceramic capacitors (0402)
C4, C24	2	10μF ±10% tantalum capacitors AVX TAJC106K016
C18	1	Open, user-supplied*
C33	1	0.01μF ±10% ceramic capacitor (0603)
D1	1	LED, T1 Package
D2	1	Open, user-supplied laser
J1, J2, J3	3	SMA connectors (edge mount)
J4	1	1 × 3-pin header (0.1in centers)
J5, J8, J9	3	Test points
JU7	1	Shunt
L1, L7	2	Ferrite beads Murata BLM18HG601SN-1

DESIGNATION	QTY	DESCRIPTION
L2, L3, L6	3	Ferrite beads Murata BLM18HG102SN-1
Q1, Q7	2	Transistors Zetex FM591A NPN
Q3	1	Transistor Zetex FM491A PNP
R1	1	10kΩ variable resistor
R2, R16	2	0Ω resistors (0402)
R3	1	Open, user-supplied
R4	1	4.3kΩ ±5% resistor (0402)
R5	1	1kΩ ±5% resistor (0402)
R6	1	1.8kΩ ±5% resistor (0402)
R7, R14	2	100kΩ variable resistors
R8	1	50kΩ variable resistor
R15	1	511Ω ±1% resistor (0402)
R17	1	24.9Ω ±1% resistor (0402)*
R19	1	49.9Ω ±1% resistor (0402)
R27	1	24.9Ω ±1% resistor (0402)**
R39	1	1kΩ ±5% resistor (0603)
R40	1	10Ω ±5% resistor (0603)

MAX3996 Evaluation Kit

Component List (continued)

DESIGNATION	QTY	DESCRIPTION
TP1-TP6, TP11, TP12	8	Test points
U1	1	MAX3996CGP (20-QFN)
U6	1	MAX4322EUK-T (5-SOT23)
None	1	MAX3996 EV kit circuit board, rev B
None	1	MAX3996 data sheet

*These components are part of the compensation network, which reduces overshoot and ringing. Parasitic series inductance introduces a zero into the laser's frequency response. R17 and C18 add a pole to cancel this zero. Starting values for most coaxial lasers is R17 = 24.9Ω in series with C18 = 2pF. These values should be experimentally adjusted until the output waveform is optimized.

**For electrical evaluation only.

Quick Start

Electrical Evaluation

In the electrical configuration, a test circuit is included to emulate a semiconductor laser with a monitor photodiode. Monitor diode current is provided by Q7, which is controlled by an operational amplifier (U6). The test circuit consisting of U6 and Q7 applies the simulated monitor diode current (the laser bias current divided by a factor of 100) to the MD pin of the MAX3996. To ensure proper operation in the electrical configuration, set up the evaluation board as follows:

- 1) Ensure that SP9 and SP10 are shorted in order to use the photodiode emulator circuitry. Ensure that SP1 is open.
- 2) Make sure nothing is installed in the laser socket (Figure 1).
- 3) Ensure that R27 is installed.
- 4) Confirm that C18 is open.
- 5) Set potentiometers R1 and R14 ($R_{SET} = R1 + R14$) to midscale by turning their screws clockwise at least 30 revolutions or until they faintly click, and then counterclockwise for 15 revolutions. This sets the regulation point for the simulated photodiode current to $1.12V/(5k\Omega + 50k\Omega) = 20.4\mu A$. The photodiode emulator circuit regulates the DC bias current into Q7 to $100 \times 20.4\mu A \approx 2mA$.
- 6) Set the potentiometer R8 (RMODSET) to maximum resistance by turning the screw counterclockwise

until it clicks faintly (30 full revolutions in the 0Ω to 50kΩ range of the multiturn potentiometer). This minimizes the modulation current.

- 7) Set the potentiometer R7 (R_{TC}) to maximum resistance by turning the screw counterclockwise until it clicks faintly (30 revolutions in the 0Ω to 100kΩ range of the multiturn potentiometer). This minimizes the temperature coefficient (tempco) of the modulation current.
- 8) Place jumpers across pin 2 (TX_DISABLE) and pin 3 (GND) of J4 (pin 1 is the square pad). This enables the output.
- 9) Attach a high-speed oscilloscope with 50Ω inputs to J1 (OUT+) through a 50Ω characteristic impedance cable.
- 10) Apply a differential input signal to J2 (IN+) and J3 (IN-). Set the differential amplitude between 200mV_{p-p} and 2200mV_{p-p}. Note that the differential amplitude is twice the single-ended amplitude.
- 11) Apply a power-supply voltage of either 3.3V or 5V between J8 (VCC) and J9 (GND). Set the current limit to 300mA.
- 12) Apply 5V between J5 (5V) and J9 (GND). Set the current limit to 100mA. This provides power to the photodiode feedback emulator.
- 13) Adjust R8 (RMODSET) until the desired laser modulation current is achieved.

$$I_{MOD} = \frac{\text{Signal Amplitude (V)}}{25\Omega}$$

Optical Evaluation

For optical evaluation of the MAX3996, configure the evaluation kit as follows:

- 1) Open SP9 and SP10 and short SP1. This disconnects the photodiode emulator circuitry and attaches the bias to the laser.
- 2) Remove R27.
- 3) Connect a laser to the board (Figure 1).
- 4) Set potentiometers R1 and R14 ($R_{SET} = R1 + R14$) to midscale by turning the screws clockwise at least 30 revolutions or until they click faintly, and then counterclockwise 15 revolutions. This sets the regulation point for the photodiode current to $1.12V/(5k\Omega + 50k\Omega) = 20.4\mu A$. The resulting laser bias current depends on the relationship between laser power and photodiode output current.

MAX3996 Evaluation Kit

Evaluates: MAX3996

WARNING: Consult your laser data sheet to ensure that 20µA of photodiode monitor current does not correspond to excessive laser power.

- 5) Set the potentiometer R8 (R_{MODSET}) to maximum resistance by turning the screw counterclockwise until it clicks faintly (30 full revolutions in the 0Ω to 50kΩ range of the multiturn potentiometer). This minimizes the modulation current.
- 6) Set the potentiometer R7 (R_{TC}) to maximum resistance by turning the screw counterclockwise until it clicks faintly (30 revolutions in the 0Ω to 100kΩ range of the multiturn potentiometer). This minimizes the temperature coefficient (tempco) of the modulation current.
- 7) Attach a 50Ω SMA terminator to J1 (OUT+). This balances the load on the differential outputs of the MAX3966.
- 8) Place jumpers across pin 2 (TX_DISABLE) and pin 3 (GND) of J4 (pin 1 is the square pad). This enables the output.
- 9) Apply a differential input signal to J2 (IN+) and J3 (IN-). Set the differential amplitude between 200mV_{p-p} and 2200mV_{p-p}. Note that the differential amplitude is twice the single-ended amplitude.
- 10) Apply a power-supply voltage of either 3.3V or 5V between J8 (VCC) and J9 (GND). Set the current limit to 300mA.
- 11) Adjust R1 and R14 (R_{SET} = R1 + R14) until the desired laser bias current is achieved. Turning the R1 and R14 potentiometer screws clockwise increases the laser bias current.
- 12) Adjust R8 (R_{MODSET}) until the desired modulation current is achieved. Turning the R8 potentiometer screw clockwise increases the laser modulation current.
- 13) Look at the “eye” output on an oscilloscope. Laser overshoot and ringing can be improved by appropriate selection of R17 and C18, as described in the *Design Procedure* section of the MAX3996 data sheet.

Adjustment and Control Descriptions (see Quick Start first)

COMPONENT	NAME	FUNCTION
C21	CPORDLY	Removing C21 floats PORDLY pin and minimizes the power-on reset time. Refer to the <i>Design Procedures</i> section of the MAX3996 data sheet.
D1	Fault Indicator	The LED is illuminated when a fault condition has occurred. The fault condition can be cleared by removing and then reinstalling the jumper at J4.
J4	TX_DISABLE	Placing a jumper across pin 1 (VCC) and pin 2 (TX_DISABLE) of J4 disables the output (active high). Place a jumper across pin 2 (TX_DISABLE) and pin 3 (GND) of J4 to enable the outputs (pin 1 is the square pad).
R1, R14	RSET	The series combination of potentiometers R1 and R14 sets the desired laser DC-current bias point. They set the resistance from MD to ground. Turn the potentiometer screws clockwise to increase average power (decrease the resistance).
R7	RTC	Potentiometer R7 (R _{TC}), in conjunction with potentiometer R8 (R _{MODSET}), sets the tempco of the laser modulation current. Turn the potentiometer screw clockwise (decrease the resistance) to increase the tempco.
R8	RMODSET	Potentiometer R8 (R _{MODSET}), in conjunction with potentiometer R7 (R _{TC}), sets the peak-to-peak amplitude of the laser modulation current. Turn the potentiometer screw clockwise (decrease the resistance) to increase the modulation amplitude.
SP1, SP9, SP10	—	Open SP1, short SP9, and short SP10 with a solder bridge for electrical evaluation. Short SP1, open SP9, and open SP10 for optical evaluation.

MAX3996 Evaluation Kit

Evaluates: MAX3996

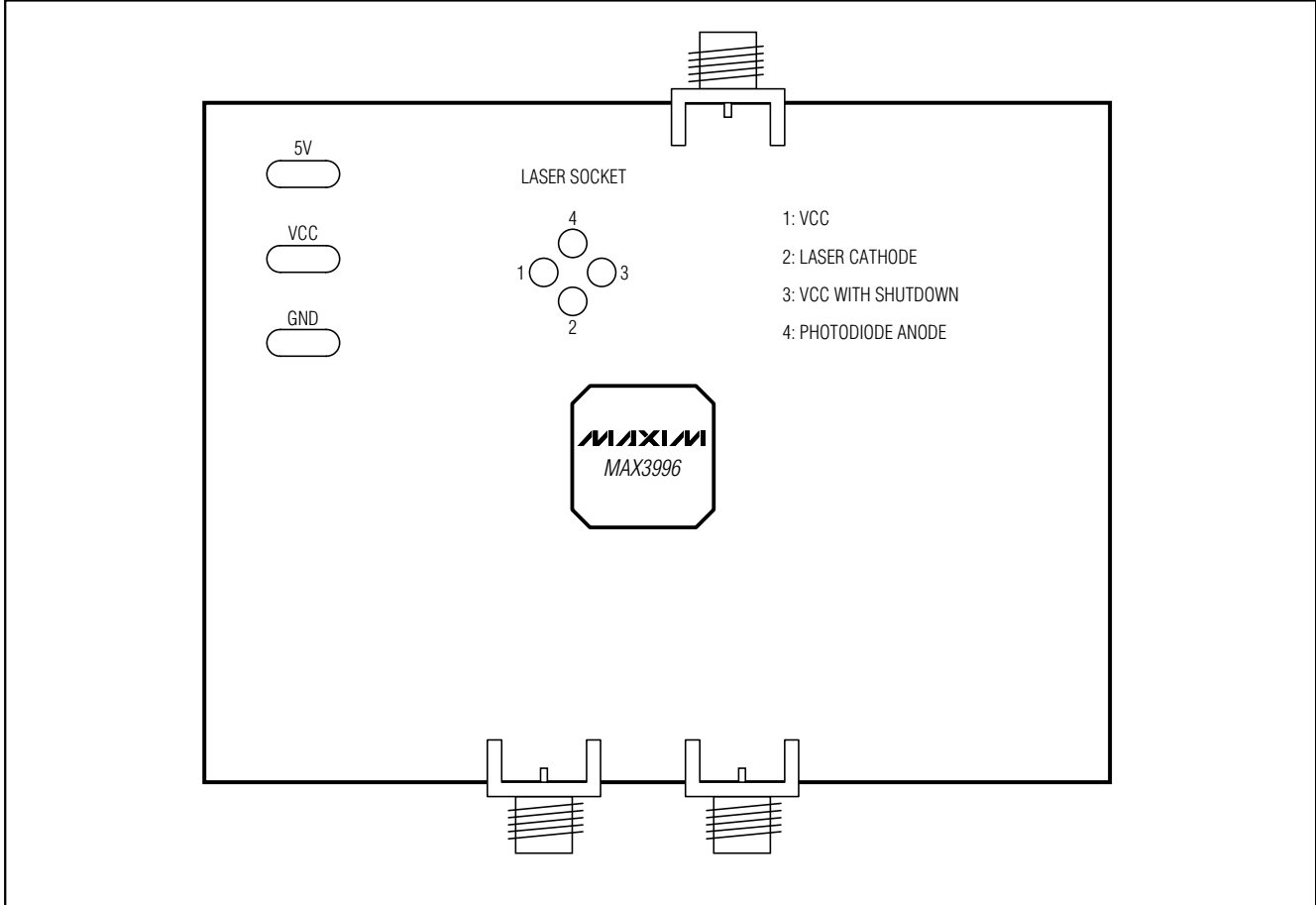

Figure 1. Optical Connection Diagram

MAX3996 Evaluation Kit

Evaluates: MAX3996

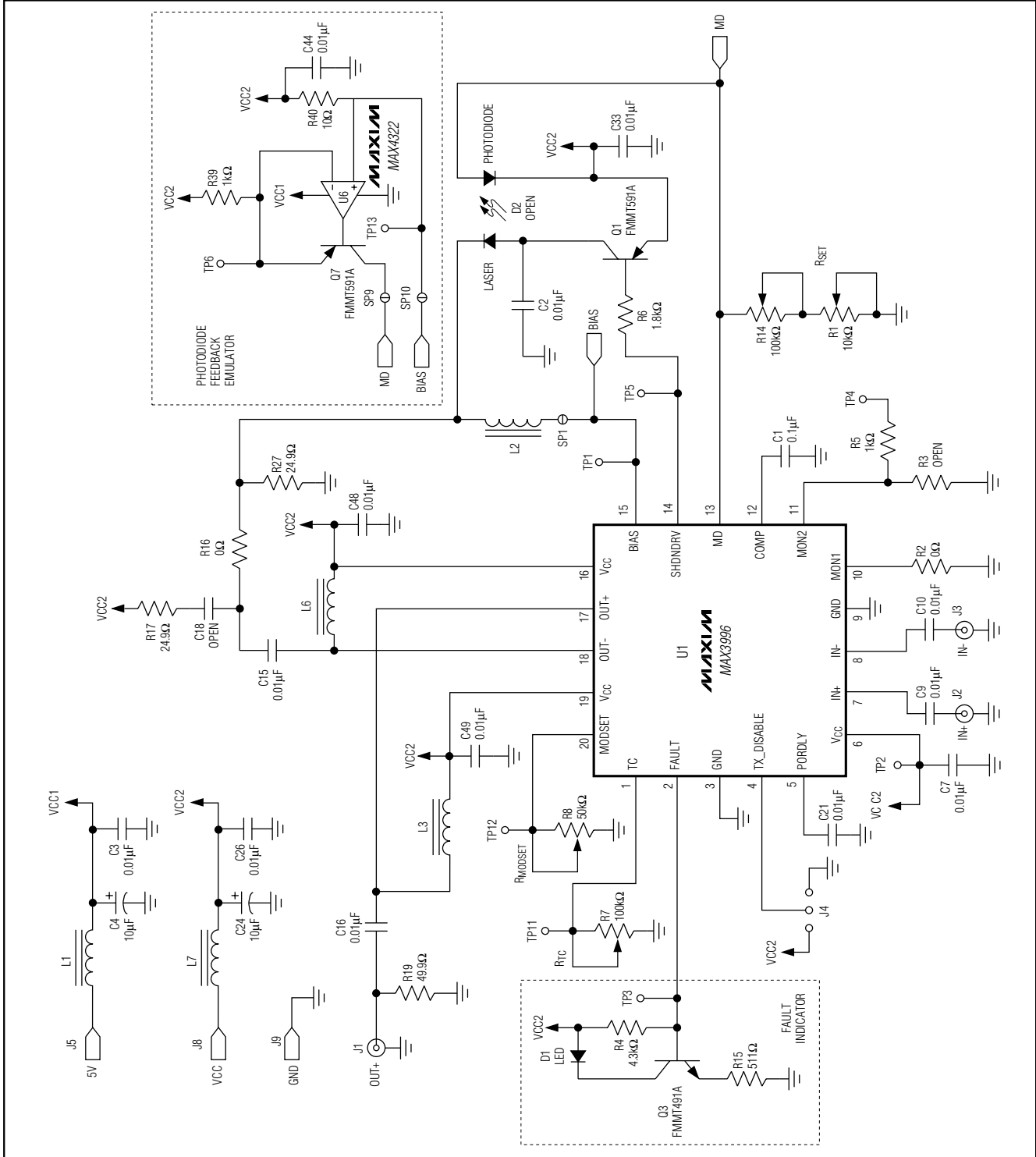

Figure 2. MAX3996 EV Kit Schematic

MAX3996 Evaluation Kit

Evaluates: MAX3996

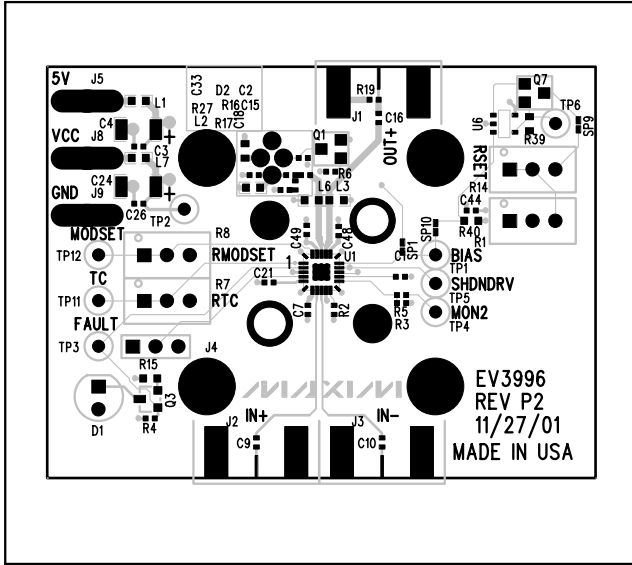

Figure 3. MAX3996 EV Kit Component Placement Guide—Component Side

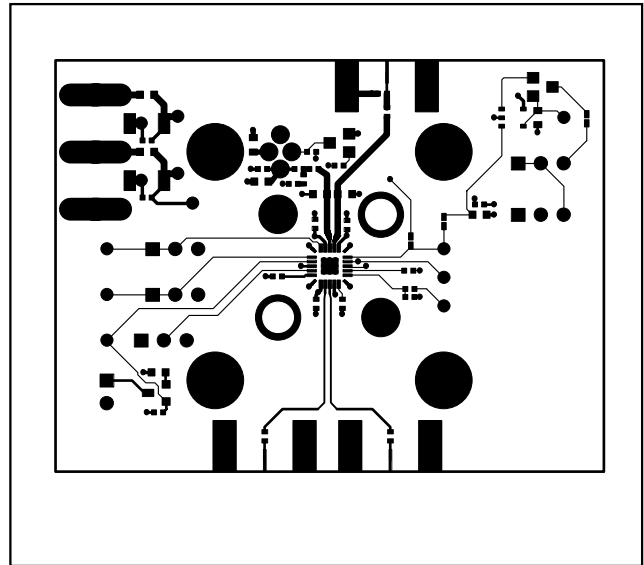

Figure 4. MAX3996 EV Kit PC Board Layout—Component Side

MAX3996 Evaluation Kit

Evaluates: MAX3996

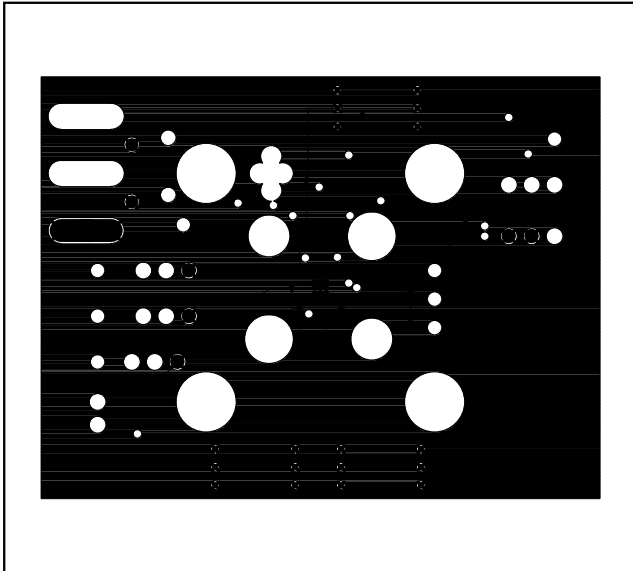

Figure 5. MAX3996 EV Kit PC Board Layout—Ground Plane

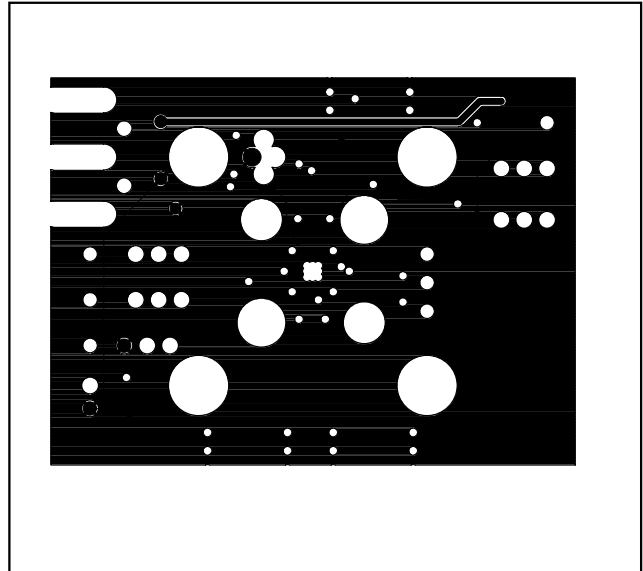

Figure 6. MAX3996 EV Kit PC Board Layout—Power Plane

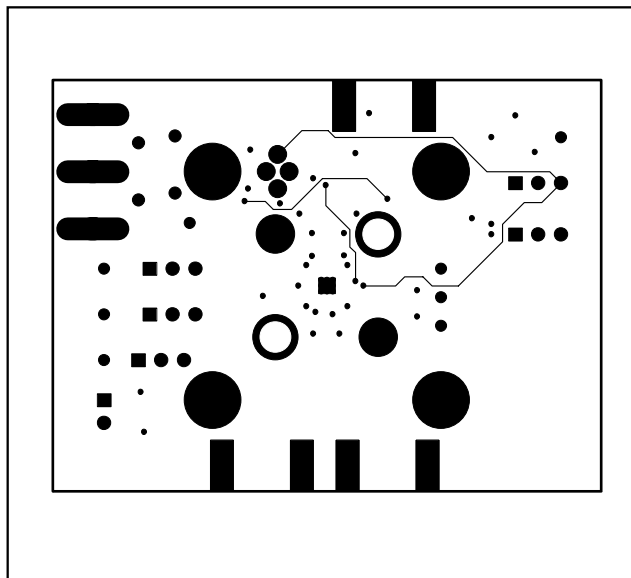

Figure 7. MAX3996 EV Kit PC Board Layout—Solder Side

Maxim cannot assume responsibility for use of any circuitry other than circuitry entirely embodied in a Maxim product. No circuit patent licenses are implied. Maxim reserves the right to change the circuitry and specifications without notice at any time.

Maxim Integrated Products, 120 San Gabriel Drive, Sunnyvale, CA 94086 408-737-7600 _____ 7