

- NOTES:
- 1.0 ELECTRICAL SPECIFICATIONS:
 - 1.1 FREQUENCY RANGE: 2.0 to 4.0 GHz
 - 1.2 INSERTION LOSS: .40dB MAX.
 - 1.3 ISOLATION: 20dB MIN
 - 1.4 VSWR (MAX): 1.35:1
 - 1.5 OUTPUT UNBALANCE:
 - 1.5.1 AMPLITUDE: 0.20dB MAX.
 - 1.5.2 PHASE: 2° MAX.
 - 1.6 MAX. INPUT POWER: 3 WATTS
 - 1.7 OPERATING TEMP. RANGE: -55°C to +125°C

- 2.0 FINISH
 - 2.1 GREY PER MIL-E-15090 TYPE II, CLASS 2
OVER MIL-C-5541 CLASS 3A
MEETS MIL-F-14072
MEETS MIL-E-5400

- 3.0 MARKING: MARK UNIT AS SHOWN.
SLK-08136-82-05

- 4.0 DIMENSIONS IN PARENTHESIS ARE
IN MILLIMETERS.

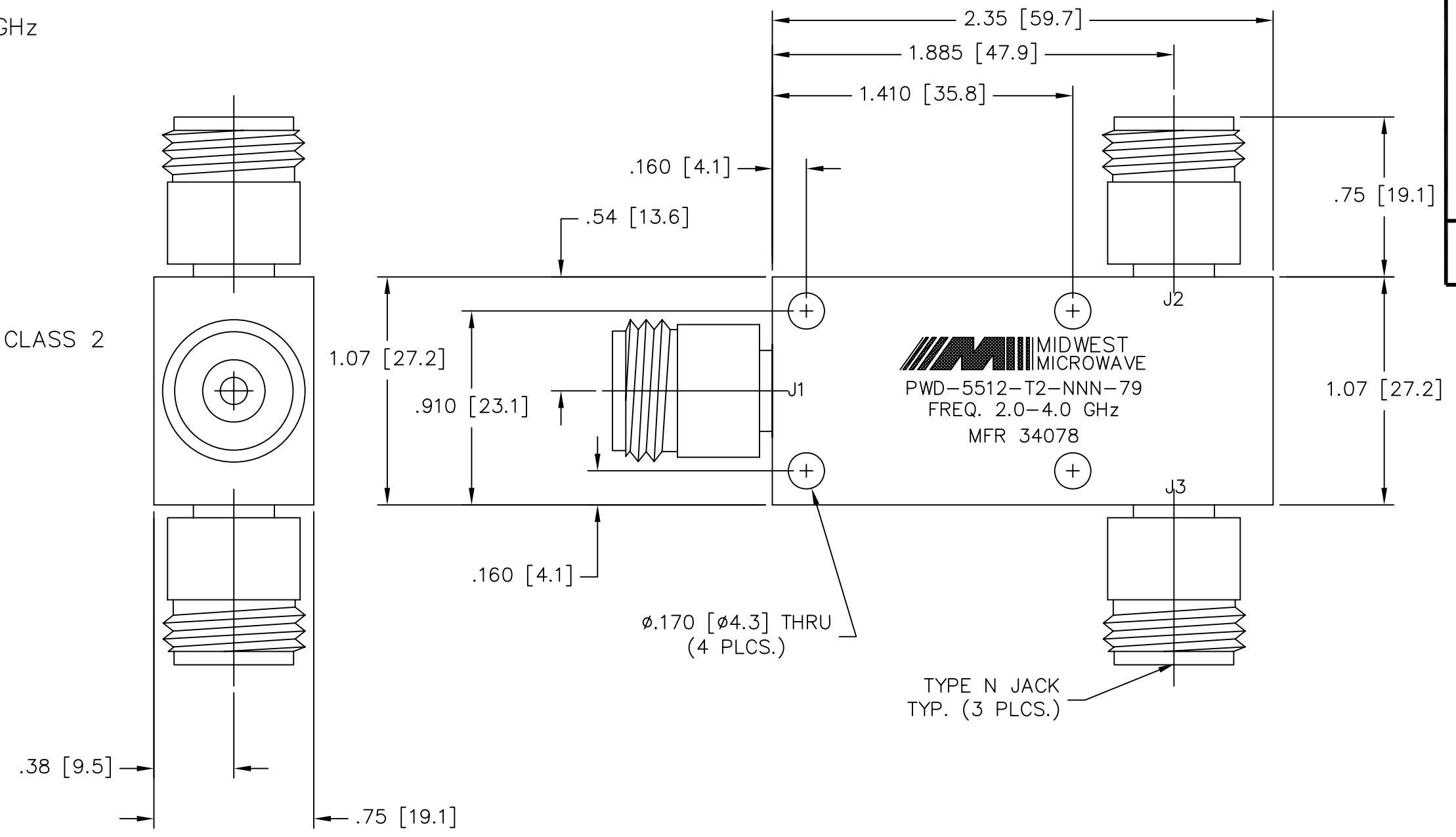

DATE	11/4/02
DESCRIPTION	RELEASED
REV.	-

UNLESS OTHERWISE NOTED DIMENSIONS ARE IN INCHES AND TOLERANCES ARE: 3 PLACE DECIMALS ±.005 2 PLACE DECIMALS ±.02 FRACTIONS ±1/64 PARALLELITY: T.I.R. _____ FLATNESS: T.I.R. _____ CONCENTRICITY: T.I.R. _____ ANGLES AND PERPENDICULARITY: ±1°	FSCM NO. 34078	MIDWEST MICROWAVE	
	NOTICE: The information contained in this drawing is proprietary and must not be used without the permission of Midwest Microwave		TITLE POWER DIVIDER
DRAWN/DATE S.ORLOV 10/31/02	ENG./DATE B.GALLAGHER 10/31/02	DRAWING NUMBER PWD-5512-T2-NNN-79	
CHECKED/DATE	APPROVED/DATE	SCALE: 2=1	SHEET 1 of 1