



Grayhill, Inc.

**70-IDC24**

Part Number:	70-IDC24
Manufacturer/Brand:	Grayhill, Inc.
Product description:	DC INPUT MODULE 3-32V
Datasheets:	<a href="#">70-IDC24.pdf</a>
RoHS Status:	 Lead free / RoHS Compliant
Ship From:	Hong Kong
Shipment Way:	DHL/Fedex/TNT/UPS/EMS



[REQUEST FOR QUOTATION](#)

Image may be representation. See specifications for product details.





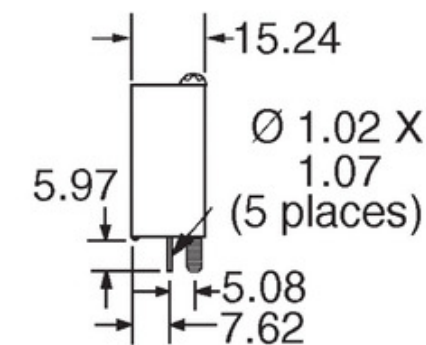



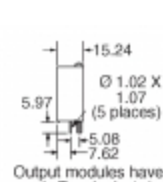

## Specifications of 70-IDC24

PART NUMBER	70-IDC24
MANUFACTURER	Grayhill, Inc.
DESCRIPTION	DC INPUT MODULE 3-32V
LEAD FREE STATUS / ROHS STATUS	Lead free / RoHS Compliant
DATA SHEET	<a href="#">70-IDC24.pdf</a>
VOLTAGE - OUTPUT	24VDC
VOLTAGE - INPUT	3 ~ 32VDC
TYPE	DC Input Module
TURN ON TIME	0.20ms
TURN OFF TIME	0.40ms
STYLE	Standard
SERIES	70
MOISTURE SENSITIVITY LEVEL (MSL)	1 (Unlimited)
MANUFACTURER STANDARD LEAD TIME	3 Weeks
LEAD FREE STATUS / ROHS STATUS	Lead free / RoHS Compliant
FEATURES	Hold Down Screw
DETAILED DESCRIPTION	DC Input Module Output Module 10mA 24VDC Output 3 ~ 32VDC Supply
CURRENT - OUTPUT	10mA
CURRENT - INPUT	18mA
COLOR	White

## Related Tags

<a href="#">Grayhill, Inc. 70-IDC24</a>	<a href="#">70-IDC24 Distributor</a>	<a href="#">70-IDC24 Supplier</a>
<a href="#">70-IDC24 Price</a>	<a href="#">70-IDC24 Pictures</a>	<a href="#">70-IDC24 Image</a>
<a href="#">70-IDC24 PDF Datasheet</a>	<a href="#">70-IDC24 Download Datasheet</a>	<a href="#">70-IDC24 Datasheet</a>
<a href="#">70-IDC24 Stock</a>	<a href="#">Buy 70-IDC24</a>	<a href="#">Buy Grayhill, Inc. 70-IDC24</a>
<a href="#">Grayhill, Inc. 70-IDC24</a>	<a href="#">Grayhill, Inc. Supplier</a>	<a href="#">Grayhill, Inc. Distributor</a>
<a href="#">Grayhill, Inc. 70-IDC24</a>	<a href="#">Grayhill Inc. 70-IDC24</a>	

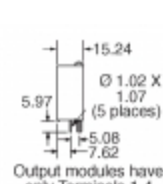
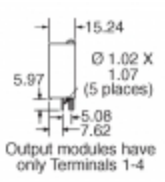
## Related Products

 <p><b>70-IDC15NP</b> Manufacturers: Grayhill, Inc. Description: AC/DC INPUT MOD 15-32V/10-32V In stock: Out stock</p> <p><a href="#">RFQ</a></p>	 <p><b>70-IAC5</b> Manufacturers: Grayhill, Inc. Description: AC INPUT MODULE 120V In stock: 51 pcs</p> <p><a href="#">RFQ</a></p>
 <p><b>70-IDC5</b> Manufacturers: Grayhill, Inc. Description: DC INPUT MODULE 3-32V In stock: 347 pcs</p> <p><a href="#">RFQ</a></p>	 <p><b>70-IAC24A</b> Manufacturers: Grayhill, Inc. Description: AC INPUT MODULE 240V In stock: Out stock</p> <p><a href="#">RFQ</a></p>
 <p><b>70-IAC24</b> Manufacturers: Grayhill, Inc. Description: AC INPUT MODULE 120V In stock: 12 pcs</p> <p><a href="#">RFQ</a></p>	 <p><b>70-IDC24NP</b> Manufacturers: Grayhill, Inc. Description: AC/DC INPUT MOD 15-32AV/10-32V In stock: Out stock</p> <p><a href="#">RFQ</a></p>
 <p><b>70-IDC5B</b> Manufacturers: Grayhill, Inc. Description: DC INPUT MODULE 3-32V In stock: 19 pcs</p> <p><a href="#">RFQ</a></p>	 <p><b>70-IDC5NP</b> Manufacturers: Grayhill, Inc. Description: AC/DC INPUT MOD 15-32V/10-32V In stock: Out stock</p> <p><a href="#">RFQ</a></p>
 <p><b>70-IDC15</b> Manufacturers: Grayhill, Inc. Description: DC INPUT MODULE 3-32V In stock: Out stock</p> <p><a href="#">RFQ</a></p>	 <p><b>70-IDC5K</b> Manufacturers: Grayhill, Inc. Description: DC INPUT MODULE 2.5-16V In stock: Out stock</p> <p><a href="#">RFQ</a></p>
 <p><b>70-IAC5A</b> Manufacturers: Grayhill, Inc. Description: AC INPUT MODULE 240V In stock: Out stock</p> <p><a href="#">RFQ</a></p>	 <p><b>70-OAC15</b> Manufacturers: Grayhill, Inc. Description: AC OUTPUT MODULE 3.5A In stock: Out stock</p> <p><a href="#">RFQ</a></p>