

Honeywell

Honeywell Sensing and Productivity Solutions

12TW49-10A

Part Number: 12TW49-10A
 Manufacturer/Brand: Honeywell Sensing and Productivity Solutions
 Product description: SWITCH TOGGLE DPDT 5A 125V
 Datasheets: [1.12TW49-10A.pdf](#)
[2.12TW49-10A.pdf](#)
 RoHS Status:  Lead free / RoHS Compliant
 Ship From: Hong Kong
 Shipment Way: DHL/Fedex/TNT/UPS/EMS

Productivity Solutions

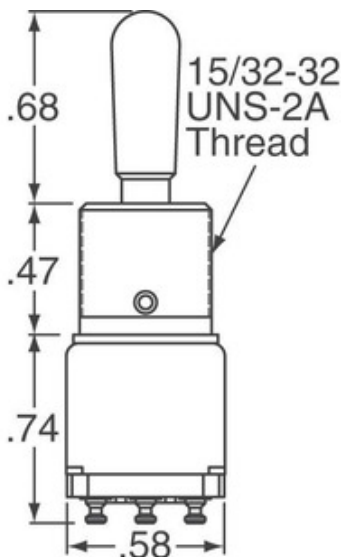

Image may be representation. See specifications for product details.

[REQUEST FOR QUOTATION](#)

Specifications of 12TW49-10A

PART NUMBER	12TW49-10A
MANUFACTURER	Honeywell Sensing and Productivity Solutions
DESCRIPTION	SWITCH TOGGLE DPDT 5A 125V
LEAD FREE STATUS / ROHS STATUS	Lead free / RoHS Compliant
DATA SHEET	1.12TW49-10A.pdf 2.12TW49-10A.pdf
VOLTAGE RATING - AC	125V
TERMINATION STYLE	Solder Turret
SWITCH FUNCTION	On-On-On
SERIES	TW
PANEL CUTOUT DIMENSIONS	Circular - 12.40mm Dia
PACKAGING	Bulk
OPERATING TEMPERATURE	-65°C ~ 71°C
MOUNTING TYPE	Panel Mount
MOISTURE SENSITIVITY LEVEL (MSL)	1 (Unlimited)
LEAD FREE STATUS / ROHS STATUS	Lead free / RoHS Compliant
INGRESS PROTECTION	Environment Proof
ILLUMINATION VOLTAGE (NOMINAL)	-
ILLUMINATION TYPE, COLOR	-
ILLUMINATION	Non-Illuminated
FEATURES	White Actuator
ELECTRICAL LIFE	-
DETAILED DESCRIPTION	Toggle Switch DPDT Panel Mount
CURRENT RATING	5A (AC)
CIRCUIT	DPDT
BUSHING THREAD	15/32-32
ACTUATOR TYPE	Locking Lever
ACTUATOR MATERIAL	-
ACTUATOR LENGTH	26.67mm

Related Tags

Honeywell Sensing and Productivity Solutions 12TW49-10A	12TW49-10A Distributor	12TW49-10A Supplier
12TW49-10A Price	12TW49-10A Pictures	12TW49-10A Image
12TW49-10A PDF Datasheet	12TW49-10A Download Datasheet	12TW49-10A Datasheet
12TW49-10A Stock	Buy 12TW49-10A	Buy Honeywell Sensing and Productivity Solutions 12TW49-10A
Honeywell Sensing and Productivity Solutions 12TW49-10A	Honeywell Sensing and Productivity Solutions Supplier	Honeywell Sensing and Productivity Solutions Distributor
Honeywell Sensing and Productivity Solutions 12TW49-10A	HONEYWELL 12TW49-10A	Honeywell Sensing and Control EMEA 12TW49-10A
Honeywell Sensing and Productivity Solutions T&M 12TW49-10A		

Related Products

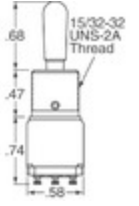
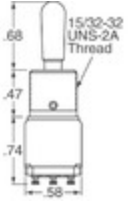
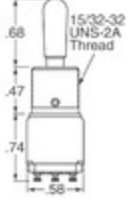
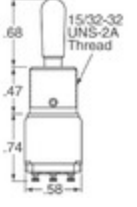
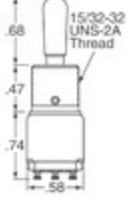
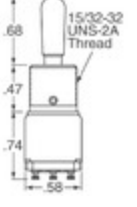
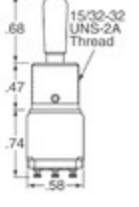
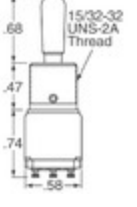
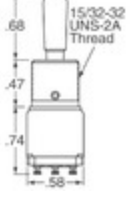
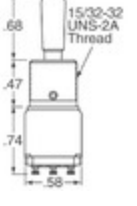
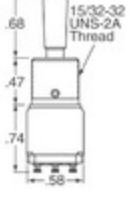
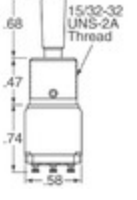
 <p>12TW49-3D Manufacturers: Honeywell Sensing and Productivity Solutions Description: SWITCH TOGGLE DPDT 5A 125V In stock: Out stock RFQ</p>	 <p>12TW49-21K Manufacturers: Honeywell Sensing and Productivity Solutions Description: SWITCH TOGGLE DPST 5A 125V In stock: Out stock RFQ</p>
 <p>12TW438-10 Manufacturers: Honeywell Sensing and Productivity Solutions Description: SWITCH TOGGLE DPDT 5A 125V In stock: Out stock RFQ</p>	 <p>12TW70-514N Manufacturers: Honeywell Sensing and Productivity Solutions Description: SWITCH TOGGLE DPDT 5A 125V In stock: Out stock RFQ</p>
 <p>12TW59-7N Manufacturers: Honeywell Sensing and Productivity Solutions Description: SWITCH TOGGLE DPDT 5A 125V In stock: Out stock RFQ</p>	 <p>12TW59-3D Manufacturers: Honeywell Sensing and Productivity Solutions Description: SWITCH TOGGLE DPDT 5A 125V In stock: Out stock RFQ</p>
 <p>12TW59-50M Manufacturers: Honeywell Sensing and Productivity Solutions Description: SWITCH TOGGLE DPDT 5A 125V In stock: Out stock RFQ</p>	 <p>12TW418-10 Manufacturers: Honeywell Sensing and Productivity Solutions Description: SWITCH TOGGLE DPDT 5A 125V In stock: Out stock RFQ</p>
 <p>12TW48-3 Manufacturers: Honeywell Sensing and Productivity Solutions Description: SWITCH TOGGLE DPDT 5A 125V In stock: Out stock RFQ</p>	 <p>12TW47-10 Manufacturers: Honeywell Sensing and Productivity Solutions Description: SWITCH TOGGLE DPDT 5A 125V In stock: Out stock RFQ</p>
 <p>12TW47-1 Manufacturers: Honeywell Sensing and Productivity Solutions Description: SWITCH TOGGLE DPDT 5A 125V In stock: Out stock RFQ</p>	 <p>12TW418-3 Manufacturers: Honeywell Sensing and Productivity Solutions Description: SWITCH TOGGLE DPDT 5A 125V In stock: Out stock RFQ</p>