



Honeywell Sensing and

MLH350BSL01A

Part Number:	MLH350BSL01A
Manufacturer/Brand:	Honeywell Sensing and Productivity Solutions
Product description:	MLH ALL METAL PRESS SENSE -ATF
Datasheets:	1.MLH350BSL01A.pdf 2.MLH350BSL01A.pdf
RoHS Status:	 Lead free / RoHS Compliant
Ship From:	Hong Kong
Shipment Way:	DHL/Fedex/TNT/UPS/EMS

[REQUEST FOR QUOTATION](#)

Productivity Solutions

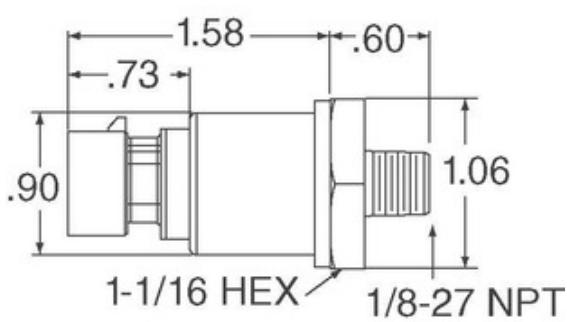

Image may be representation. See specifications for product details.





Specifications of MLH350BSL01A

PART NUMBER	MLH350BSL01A
MANUFACTURER	Honeywell Sensing and Productivity Solutions
DESCRIPTION	MLH ALL METAL PRESS SENSE -ATF
LEAD FREE STATUS / ROHS STATUS	Lead free / RoHS Compliant
DATA SHEET	1.MLH350BSL01A.pdf 2.MLH350BSL01A.pdf
VOLTAGE - SUPPLY	5 V ~ 6 V
TERMINATION STYLE	Connector
SUPPLIER DEVICE PACKAGE	-
SERIES	MLH
PRESSURE TYPE	Sealed Gauge
PORT STYLE	Threaded
PORT SIZE	Male - 1/4" (6.35mm) NPT
PACKAGE / CASE	Cylinder, Metal
OUTPUT TYPE	Analog Voltage
OUTPUT	0.5 V ~ 4.5 V
OPERATING TEMPERATURE	-40°C ~ 125°C
OPERATING PRESSURE	5076.32 PSI (35000 kPa)
MOISTURE SENSITIVITY LEVEL (MSL)	1 (Unlimited)
MAXIMUM PRESSURE	10152.64 PSI (70000 kPa)
LEAD FREE STATUS / ROHS STATUS	Lead free / RoHS Compliant
FEATURES	Amplified Output, Temperature Compensated
DETAILED DESCRIPTION	Pressure Sensor 5076.32 PSI (35000 kPa) Sealed Gauge Male - 1/4" (6.35mm) NPT 0.5 V ~ 4.5 V Cylinder, Metal
ACCURACY	±0.25%

Related Tags

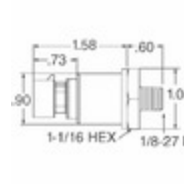
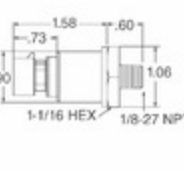
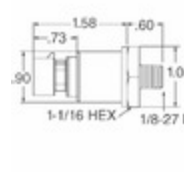
Honeywell Sensing and Productivity Solutions MLH350BSL01A	MLH350BSL01A Distributor	MLH350BSL01A Supplier
MLH350BSL01A Price	MLH350BSL01A Pictures	MLH350BSL01A Image
MLH350BSL01A PDF Datasheet	MLH350BSL01A Download Datasheet	MLH350BSL01A Datasheet
MLH350BSL01A Stock	Buy MLH350BSL01A	Buy Honeywell Sensing and Productivity Solutions MLH350BSL01A
Honeywell Sensing and Productivity Solutions MLH350BSL01A	Honeywell Sensing and Productivity Solutions Supplier	Honeywell Sensing and Productivity Solutions Distributor
Honeywell Sensing and Productivity Solutions MLH350BSL01A	HONEYWELL MLH350BSL01A	Honeywell Sensing and Control EMEA MLH350BSL01A
Honeywell Sensing and Productivity Solutions T&M MLH350BSL01A		

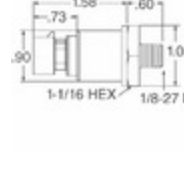
Related Products

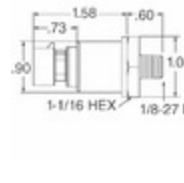
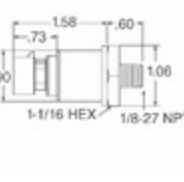
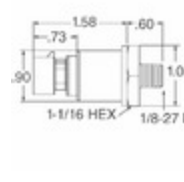
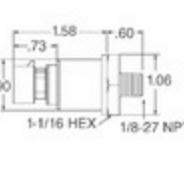
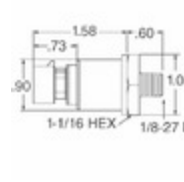
 <p>MLH350BSD14B Manufacturers: Honeywell Sensing and Productivity Solutions Description: SENSOR SEALED GAUGE 0-350 BAR In stock: Out stock</p> <p>RFQ</p>	 <p>MLH350BST12E Manufacturers: Honeywell Sensing and Productivity Solutions Description: MLH ALL METAL PRESS SENSE -ATF In stock: Out stock</p> <p>RFQ</p>
 <p>MLH350BST13E Manufacturers: Honeywell Sensing and Productivity Solutions Description: MLH ALL METAL PRESS SENSE -ATF In stock: Out stock</p> <p>RFQ</p>	 <p>MLH350BSC01D Manufacturers: Honeywell Sensing and Productivity Solutions Description: MLH ALL METAL PRESS SENSE -ATF In stock: Out stock</p> <p>RFQ</p>
 <p>MLH350BSG13D Manufacturers: Honeywell Sensing and Productivity Solutions Description: SENSOR SEALED GAUGE 0-350 BAR In stock: Out stock</p> <p>RFQ</p>	 <p>MLH350BSL07E Manufacturers: Honeywell Sensing and Productivity Solutions Description: MLH ALL METAL PRESS SENSE -ATF In stock: Out stock</p> <p>RFQ</p>
 <p>MLH350BSG14D Manufacturers: Honeywell Sensing and Productivity Solutions Description: SENSOR SEALED GAUGE 0-350 BAR In stock: 1 pcs</p> <p>RFQ</p>	 <p>MLH350BSC01B Manufacturers: Honeywell Sensing and Productivity Solutions Description: SENSOR SEALED GAUGE 0-350 BAR In stock: Out stock</p> <p>RFQ</p>
 <p>MLH350BSG17D Manufacturers: Honeywell Sensing and Productivity Solutions Description: MLH ALL METAL PRESS SENSE -ATF In stock: Out stock</p> <p>RFQ</p>	 <p>MLH350BSL15E Manufacturers: Honeywell Sensing and Productivity Solutions Description: SENSOR SEALED GAUGE 0-350 BAR In stock: Out stock</p> <p>RFQ</p>
 <p>MLH350BSL14A Manufacturers: Honeywell Sensing and Productivity Solutions Description: MLH ALL METAL PRESS SENSE -ATF In stock: Out stock</p> <p>RFQ</p>	 <p>MLH350BST07E Manufacturers: Honeywell Sensing and Productivity Solutions Description: MLH ALL METAL PRESS SENSE -ATF In stock: Out stock</p> <p>RFQ</p>