

**TRIUNE PRODUCTS**

## Features

- Ultra-low nA operating current at light load
- Best-in-class quiescent current of 20nA at Iload=0
- Best-in-class quiescent current of 100pA in disable mode
- Output voltage options of 1.2V - 4.2V in 100mV steps (programmed at manufacturing)
- Accurate output regulation
- Over-current protection

## Summary Specifications

- Low input operating voltage of 2.5V to 5.5V
- Packaged in a 8pin DFN (2x2)
- Product is lead-free, Halogen Free, RoHS / WEEE compliant

## Description

The TS14002 linear regulator is an ultra-low-power circuit which draws low nA level quiescent current at light load, but has the capability to regulate current loads as high as 150mA.

## Applications

- Portable electronics
- RFID
- Industrial
- Medical
- Energy harvesting systems
- SmartCard

## Typical Applications

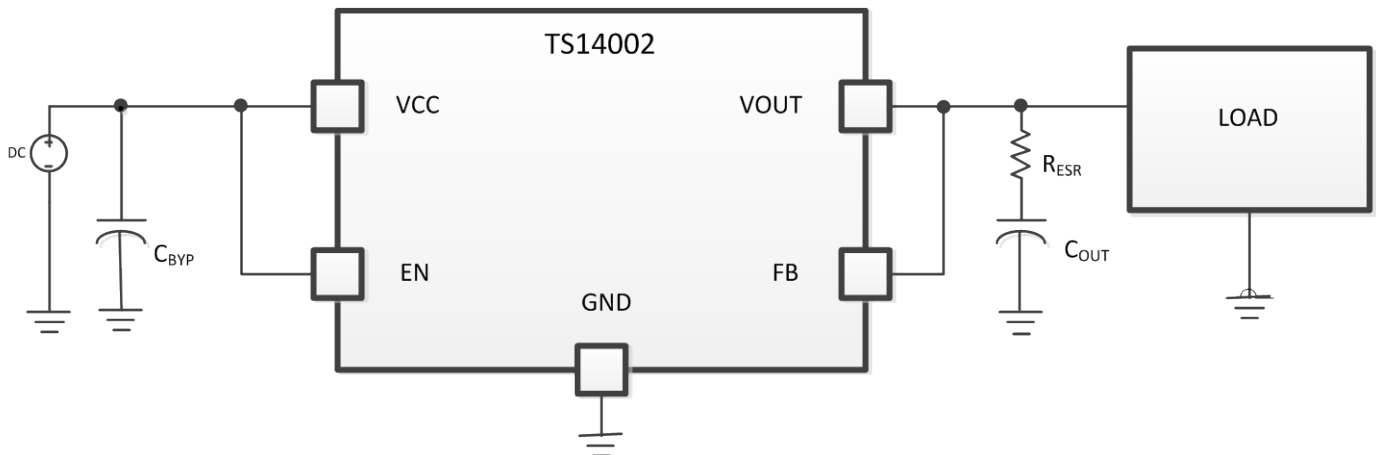

## Block Diagram

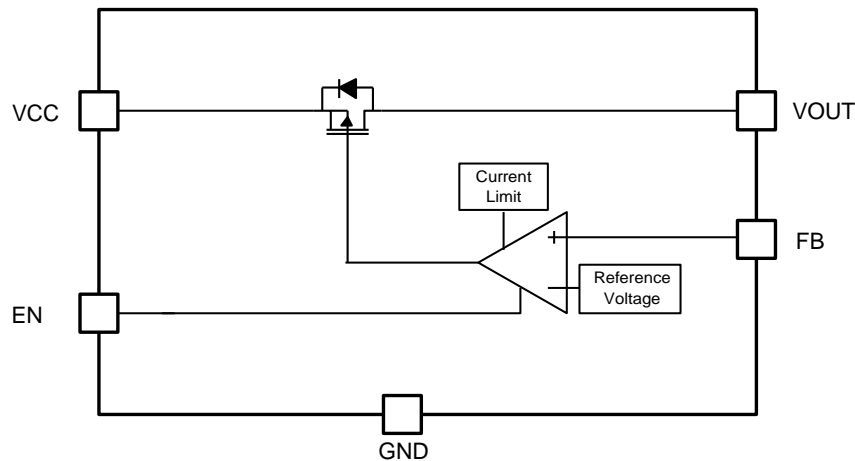

## Pin Description

| Pin # | Pin Name         | Pin Type <sup>(1)</sup> | Description                          |
|-------|------------------|-------------------------|--------------------------------------|
| 1     | GND              | P                       | Ground                               |
| 2     | V <sub>OUT</sub> | O                       | Regulated Output Voltage             |
| 3     | NC               |                         | No Connect (connect to GND or float) |
| 4     | NC               |                         | No Connect (connect to GND or float) |
| 5     | NC               |                         | No Connect (connect to GND or float) |
| 6     | FB               | I                       | Feedback Input                       |
| 7     | V <sub>CC</sub>  | P                       | Input Power                          |
| 8     | EN               | I                       | Enable Input                         |

(1) I = Input, O = Output, P = Power

## Absolute Maximum Rating

Over operating free-air temperature range unless otherwise noted<sup>(2, 3, 4)</sup>

| Parameter  | Value       | Unit |
|--|-------------|------|
| V <sub>CC</sub> , V <sub>OUT</sub> , EN, FB          | -0.3 to 6.0 | V    |
| Electrostatic Discharge (Human Body Model)           | 2           | kV   |
| Operating Junction Temperature Range, T <sub>J</sub> | -40 to 85   | °C   |
| Storage Temperature Range, T <sub>STG</sub>          | -65 to 150  | °C   |
| Reflow Temperature (soldering, 10 seconds)           | 260         | °C   |

(2) Stresses beyond those listed under “absolute maximum ratings” may cause permanent damage to the device. These are stress ratings only, and functional operation of the device at these or any other conditions beyond those indicated under “recommended operating conditions” is not implied. Exposure to absolute-maximum-rated conditions for extended periods may affect device reliability.

(3) All voltage values are with respect to network ground terminal.

(4) ESD testing is performed according to the respective JESD22 JEDEC standard.

## Thermal Characteristics

| Package DFN | $\theta_{JA}$ (°C/W)<br>(See Note 5) | $\theta_{JC}$ (°C/W)<br>(See Note 6) |
|-------------|--------------------------------------|--------------------------------------|
| 8 pin       | 73.1                                 | 10.7                                 |

(5) This assumes a FR4 board only.

(6) This assumes a 1 Oz. Copper JEDEC standard board with thermal vias – See Exposed Pad section and application note for more information.

## Recommended Operating Conditions

| Parameter   | Min | Typ | Max | Unit |
|---|-----|-----|-----|------|
| Unregulated Supply Input Voltage ( $V_{CC}$ )         | 2.5 |     | 5.5 | V    |
| Enable Input (EN)                                     | 0   |     | 5   | V    |
| Regulated Supply Output Voltage ( $V_{OUT}$ ) typical | 1.2 |     | 4.2 | V    |
| Operating Ambient Temperature, $T_A$ (Note 7)         | -40 |     | 55  | °C   |
| Operating Junction Temperature, $T_J$                 | -40 |     | 85  | °C   |
| Input Bypass Capacitor ( $C_{BYP}$ )                  |     | 2.2 |     | uF   |
| Output Bypass Capacitor ( $C_{OUT}$ )                 | 1   | 2.2 | 4.7 | uF   |

(7)  $T_A$  Max shown here is a guideline. Higher  $T_A$  can be tolerated if  $T_J$  does not exceed the Absolute Maximum Rating.

## Characteristics

Electrical characteristics,  $V_{CC} = 2.5V$  to  $5.5V$ ,  $T_J = 25C$ ,  $C_{OUT} = 2.2uF$  unless otherwise noted

| Symbol           | Parameter                          | Condition  | Min                | Typ | Max                | Unit |
|------------------|------------------------------------|--|--------------------|-----|--------------------|------|
| $V_{CC}$         | Input Supply Voltage               |  | 2.5                |     | 5.5                | V    |
| $V_{il_{EN}}$    | Input Low Logic Level              |  |                    |     | $0.3 \cdot V_{CC}$ | V    |
| $V_{ih_{EN}}$    | Input High Logic Level             |  | $0.7 \cdot V_{CC}$ |     |                    | V    |
| $I_{qq}$         | Quiescent Current (note 9)         | $V_{CC} = 2.5V$ to $5.5V$ , $I_{OUT} = 0$<br>(Note 9)  |                    | 20  |                    | nA   |
| $I_{qq-disable}$ | Quiescent Current:<br>Disable Mode | $I_{OUT} = 0$ , EN = 0                                 |                    | 100 |                    | pA   |
| $I_{op-gnd}$     | Operating Current                  | $V_{CC} = V_{CC\_MIN}$ , $I_{OUT} = 150mA$<br>(Note 8) |                    | 200 |                    | uA   |
| $I_{out}$        | Load Capability                    | $V_{out\_nominal}$ from 1.2V to 3.5V                   | 0                  |     | 150                | mA   |
|                  |                                    | $V_{out\_nominal} > 3.5V$                              | 0                  |     | 100                |      |

(8) If  $V_{out\_nominal} < 2.5V$ , then  $V_{CC\_MIN} = 2.5V$ , otherwise  $V_{CC\_MIN} = V_{out} + 0.3V$ .  $V_{CC\_MAX}$  is always 5.5V.  $V_{CC\_NOM}$  is the average of  $V_{CC\_MAX}$  and  $V_{CC\_MIN}$ .

(9) Not tested in production, but has been evaluated on samples

## Characteristics Continued

Electrical characteristics,  $V_{CC} = 2.5V$  to  $5.5V$ ,  $T_J = 25C$ , unless otherwise noted

| Symbol      | Parameter                   | Condition   | Min | Typ | Max | Unit |
|-------------|-----------------------------|---|-----|-----|-----|------|
| $V_{Line}$  | DC Line Regulation          | $V_{CC} = V_{CC\_MIN}$ to $V_{CC\_MAX}$<br>$V_{OUT} = 1.8V$ to $4.2V$ ,<br>$I_{OUT} = 50mA$ |     | 0.5 | 4   | %    |
|             |                             | $V_{CC} = V_{CC\_MIN}$ to $V_{CC\_MAX}$<br>$V_{OUT} < 1.8V$ ,<br>$I_{OUT} = 50mA$           |     |     | 4   | %    |
| $V_{Load}$  | DC Load Regulation          | $V_{CC} = V_{CC\_NOM}$<br>$I_{OUT} = 0.02mA$ to $150mA$ ,                                   |     | 1   | 3   | %    |
| $I_{limit}$ | Short circuit current limit | $V_{OUT}$ forced to GND<br>(Note 9)   | 185 | 200 |     | mA   |

(9) Not tested in production, but has been evaluated on samples

# Typical Characteristics

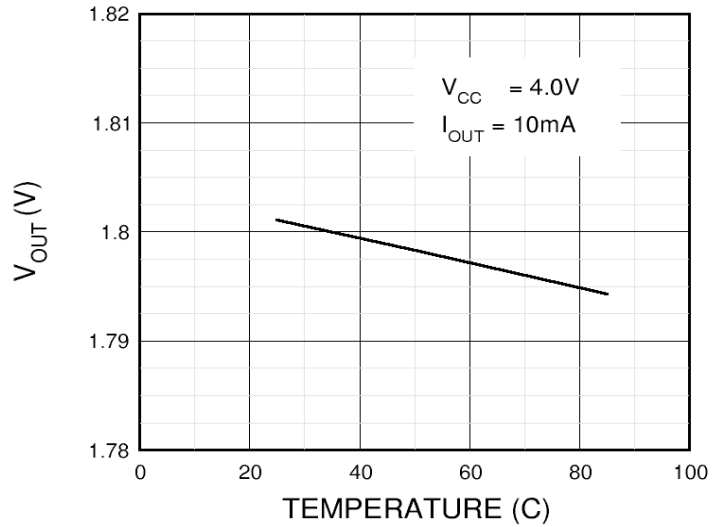
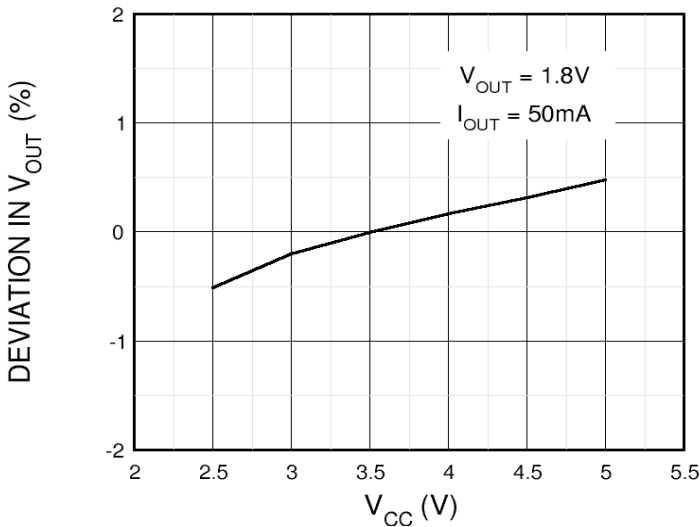
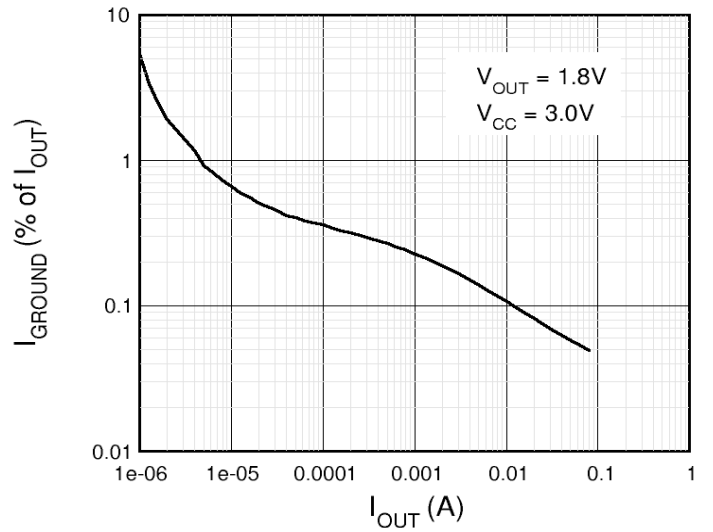
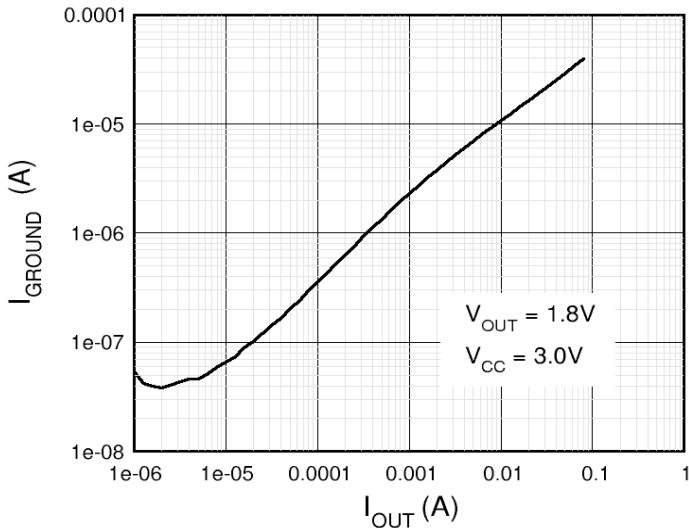
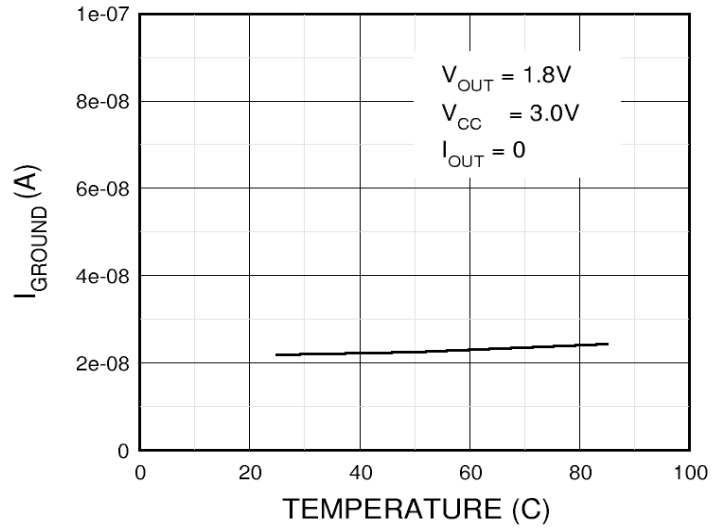
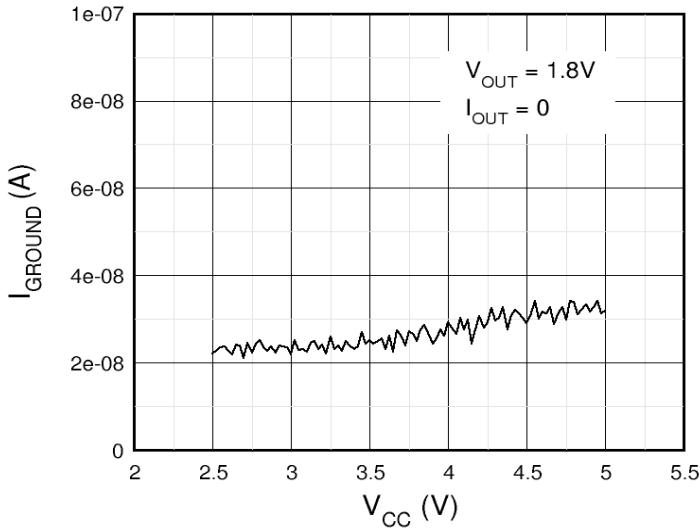

Dropout Voltage When  $V_{OUT}$  Drops By 3%

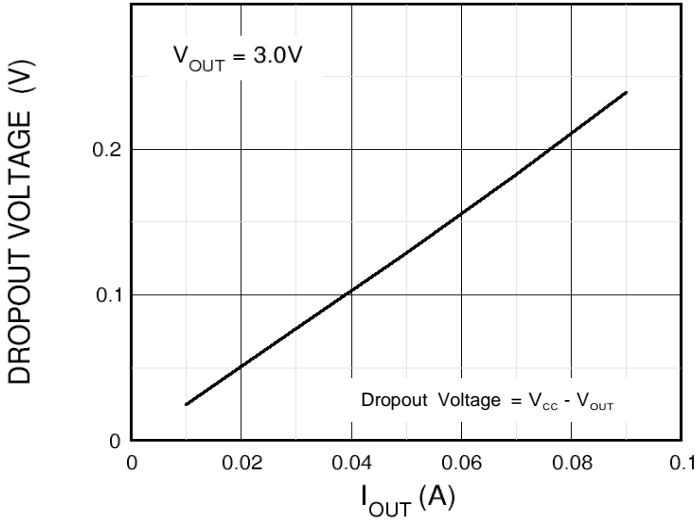

Load Regulation Performance

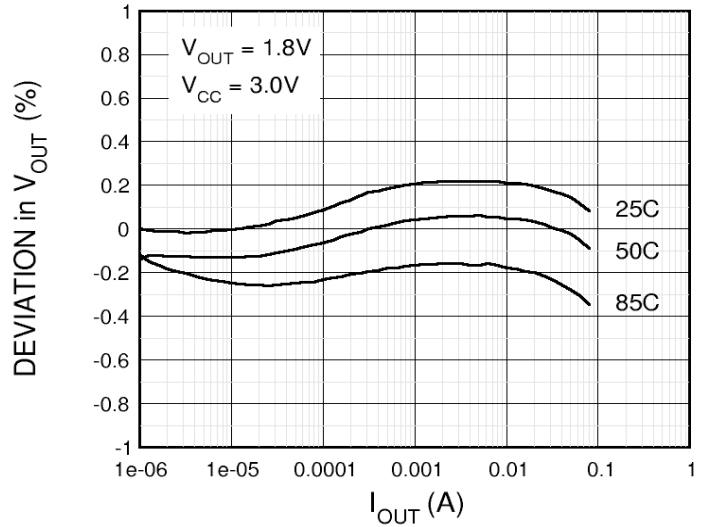

Load Step Response

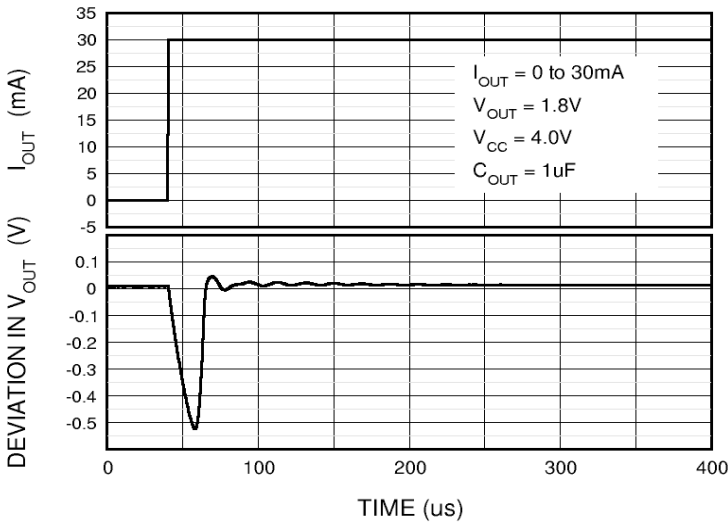

Load Step Response

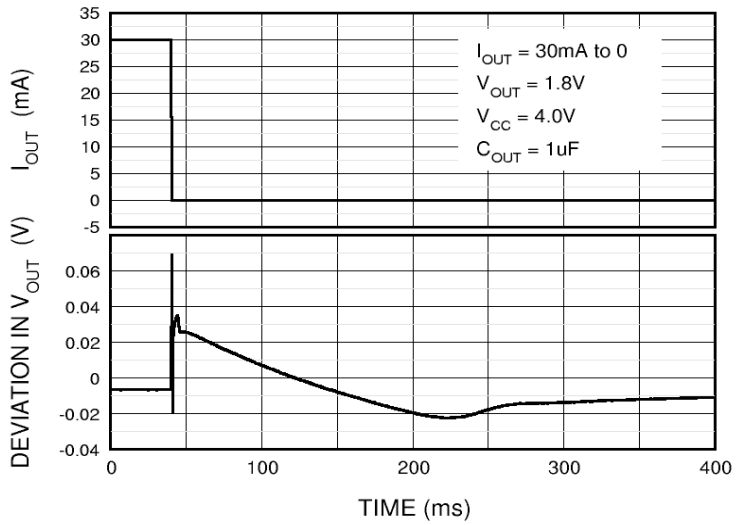

Load Step Response

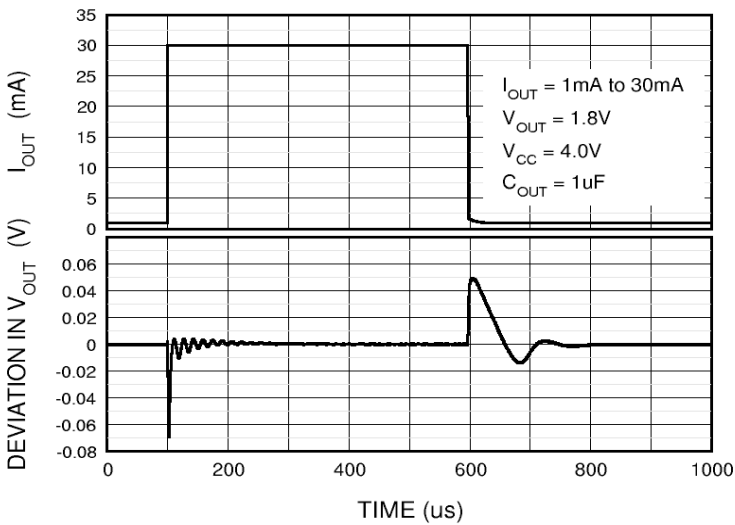

Line Step Response

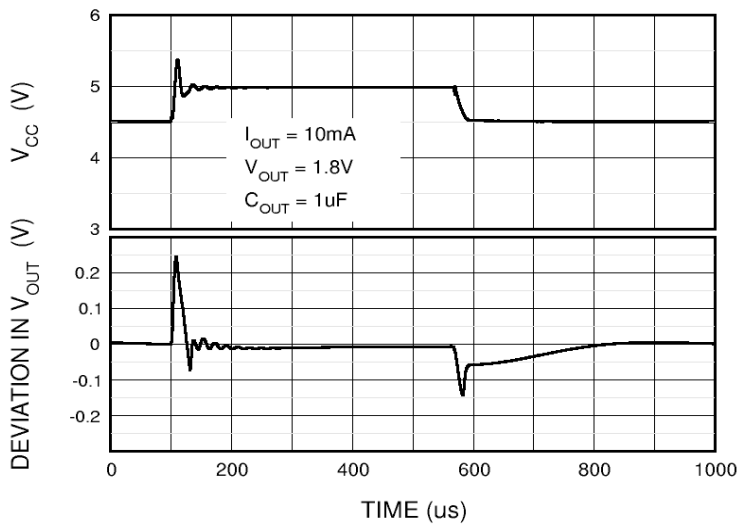

Output Enable Timing

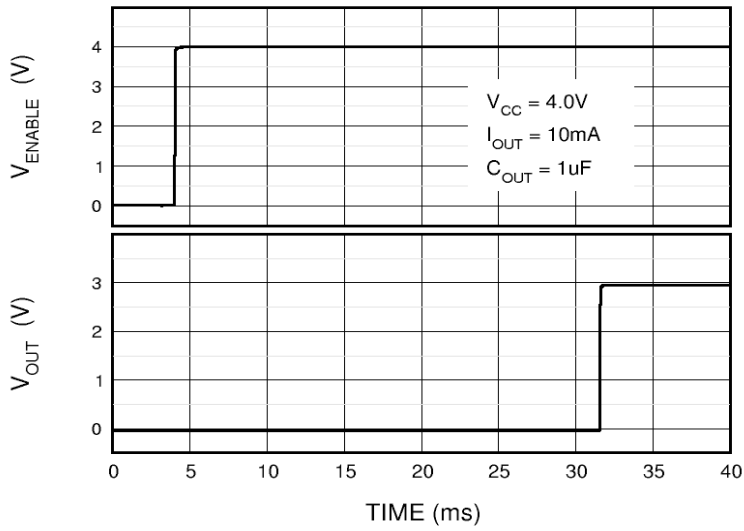

Power Supply Rejection Ratio

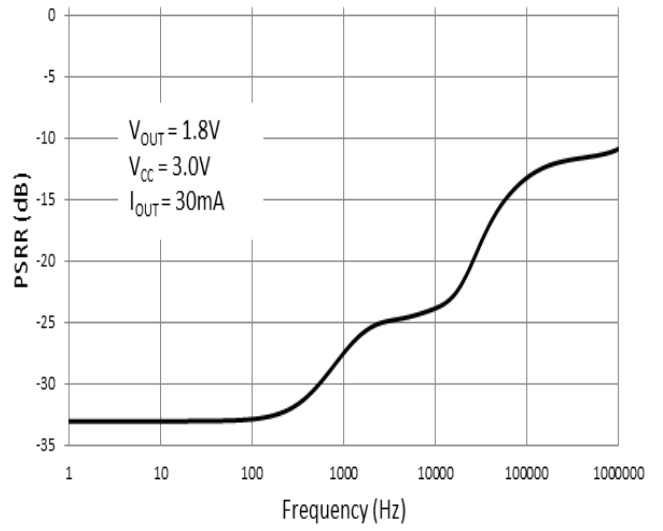

# Package Mechanical Drawings (all dimensions in mm)

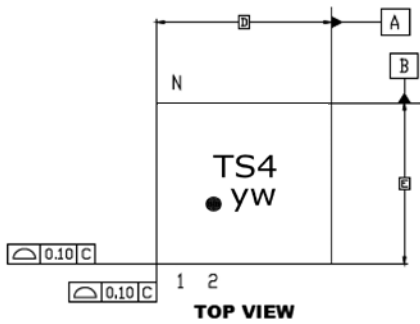

Marking for the 2.0 x 2.0 mm MLPD 8 Lead package:

nnn = Part Number (Example: TS4) - Reference Part No. Code for small MLP  
 yw = Datecode (Reference Package Marking Design Guide lines, Appendix A)

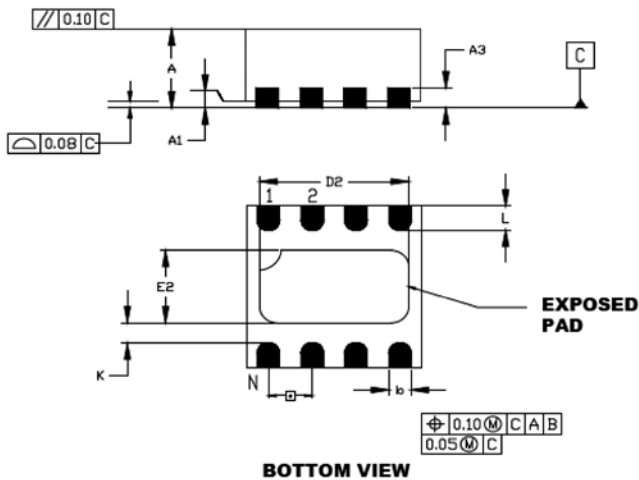

|                        | Units | MILLIMETERS      |      |      |
|------------------------|-------|------------------|------|------|
|                        |       | Dimension Limits | MIN  | NOM  |
| Number of Pins         | N     | 8                |      |      |
| Pitch                  | e     | 0.50 BSC         |      |      |
| Overall Height         | A     | 0.80             | 0.90 | 1.00 |
| Standoff               | A1    | 0.00             | 0.02 | 0.05 |
| Contact Thickness      | A3    | 0.20 REF         |      |      |
| Overall Length         | D     | 2.00 BSC         |      |      |
| Exposed Pad Width      | E2    | 0.75             | 0.90 | 1.00 |
| Overall Width          | E     | 2.00 BSC         |      |      |
| Exposed Pad Length     | D2    | 1.55             | 1.70 | 1.80 |
| Contact Width          | b     | 0.18             | 0.25 | 0.30 |
| Contact Length         | L     | 0.20             | 0.30 | 0.40 |
| Contact-to-Exposed Pad | K     | 0.20             | -    | -    |

**Notes:**

Dimensions and tolerances per ASME Y14.5M.

BSC: Basic Dimension. Theoretically exact values shown without tolerances.

REF: Reference Dimension, usually without tolerance, for information only.



# Recommended PCB Land Pattern

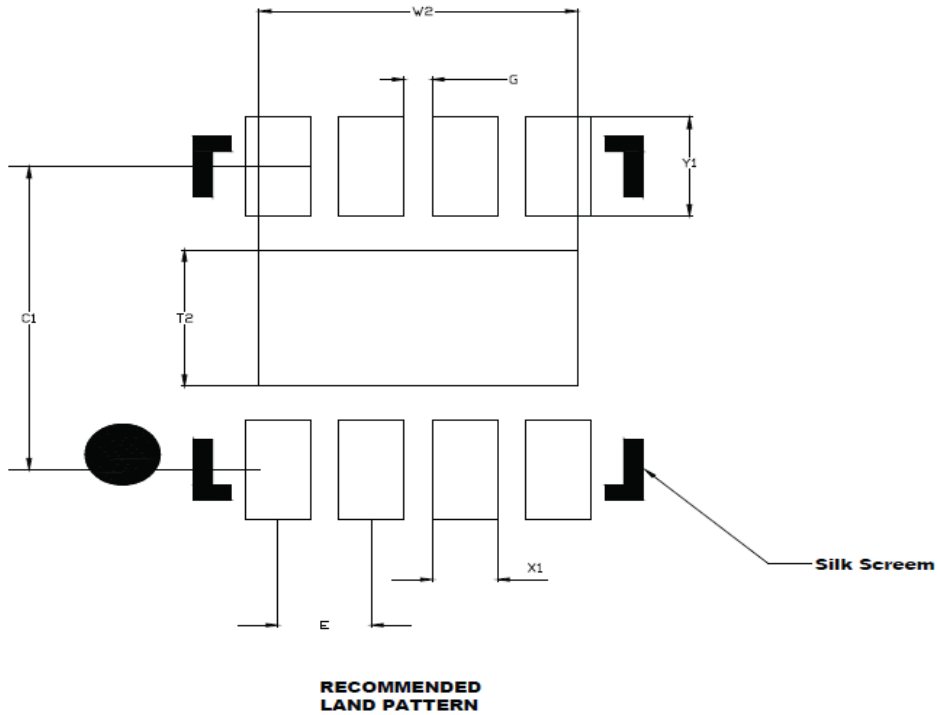

## DIMENSIONS IN MILLIMETERS

|                            | Units | MILLIMETERS      |      |      |
|----------------------------|-------|------------------|------|------|
|                            |       | Dimension Limits | MIN  | NOM  |
| Contact Pitch              | E     | 0.50 BSC         |      |      |
| Optional Center Pad Width  | W2    | -                | -    | 1.70 |
| Optional Center Pad Length | T2    | -                | -    | 0.90 |
| Contact Pad Spacing        | C1    | -                | 2.00 | -    |
| Contact Pad Spacing        | C2    | -                | -    | -    |
| Contact Pad Width (X8)     | X1    | -                | -    | 0.35 |
| Contact Pad Length (X8)    | Y1    | -                | -    | 0.65 |
| Distance Between Pads      | G     | 0.15             | -    | -    |

---

## Ordering Information

TS14002--CvvvDFNR

| Part Number | Description     |
|-------------|-----------------|
| vvv         | Output Voltage* |
| 012         | 1.2 V           |
| 015         | 1.5 V           |
| 018         | 1.8 V           |
| 020         | 2.0 V           |
| 023         | 2.3 V           |
| 025         | 2.5 V           |
| 028         | 2.8 V           |
| 030         | 3.0 V           |
| 033         | 3.3 V           |
| 042         | 4.2 V           |

\* Custom values also available (1.2V - 4.2V typical in 100mV increments)

---

## IMPORTANT NOTICE

Information relating to this product and the application or design described herein is believed to be reliable, however such information is provided as a guide only and Semtech assumes no liability for any errors in this document, or for the application or design described herein. Semtech reserves the right to make changes to the product or this document at any time without notice. Buyers should obtain the latest relevant information before placing orders and should verify that such information is current and complete. Semtech warrants performance of its products to the specifications applicable at the time of sale, and all sales are made in accordance with Semtech's standard terms and conditions of sale.

SEMTECH PRODUCTS ARE NOT DESIGNED, INTENDED, AUTHORIZED OR WARRANTED TO BE SUITABLE FOR USE IN LIFE-SUPPORT APPLICATIONS, DEVICES OR SYSTEMS, OR IN NUCLEAR APPLICATIONS IN WHICH THE FAILURE COULD BE REASONABLY EXPECTED TO RESULT IN PERSONAL INJURY, LOSS OF LIFE OR SEVERE PROPERTY OR ENVIRONMENTAL DAMAGE. INCLUSION OF SEMTECH PRODUCTS IN SUCH APPLICATIONS IS UNDERSTOOD TO BE UNDERTAKEN SOLELY AT THE CUSTOMER'S OWN RISK. Should a customer purchase or use Semtech products for any such unauthorized application, the customer shall indemnify and hold Semtech and its officers, employees, subsidiaries, affiliates, and distributors harmless against all claims, costs damages and attorney fees which could arise.

The Semtech name and logo are registered trademarks of the Semtech Corporation. All other trademarks and trade names mentioned may be marks and names of Semtech or their respective companies. Semtech reserves the right to make changes to, or discontinue any products described in this document without further notice. Semtech makes no warranty, representation or guarantee, express or implied, regarding the suitability of its products for any particular purpose. All rights reserved.

© Semtech 2016

---

## Contact Information

Semtech Corporation  
200 Flynn Road, Camarillo, CA 93012  
Phone: (805) 498-2111, Fax: (805) 498-3804  
[www.semtech.com](http://www.semtech.com)